

Data Sheet

WÖHR COMBILIFT 552/552_MR



- For driving through to reach a rear parking in combination with:
 - Combilift 552, 542, 543

- Platform load options:
 - max. 2000 kg, load per wheel 500 kg
 - max. 2600 kg, load per wheel 650 kg
 - max. 3000 kg, load per wheel 750 kg

- Platform load can be increased later (also individual parking places)

- Platforms are in horizontal position to drive on

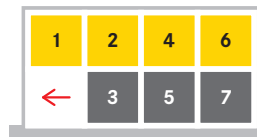

The parking places 3 and 5 are shifted to the left.

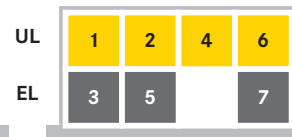

You can drive into the rear system via the empty place that has now become free

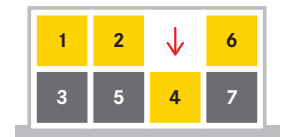

or an UL parking place can be lowered.

Length dimensions underground car park (height dimensions see page 2)

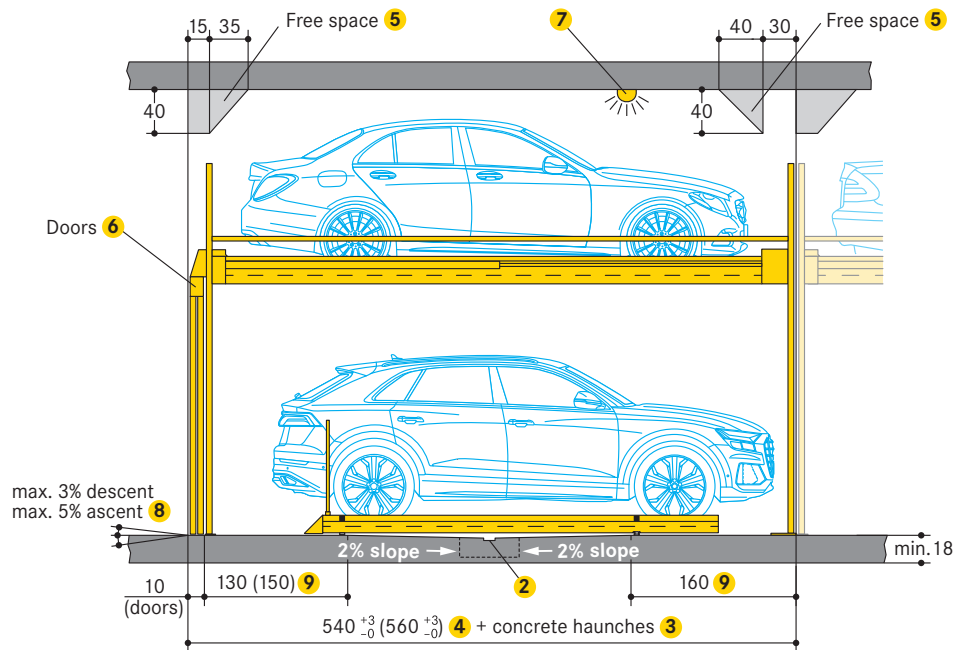

- 1 Increasing of platform load at extra cost
- 2 Drainage channels (performed by the customer)
- 3 Channels or undercuts/concrete haunches (performed by the customer):
 - not allowed along the floor-to-wall joints
 - should channels or undercuts be necessary, the system width needs to be reduced or the pit needs to be wider
- 4 500 cm vehicle length = 540 cm installation length (including doors)
520 cm vehicle length = 560 cm installation length (including doors)
Due to the increasing length of vehicles, we recommend an installation length of 560 cm in order to be able to park mid-range models in the future.
- 5 Free spaces:
 - please ask WÖHR for the dimension sheets
- 6 Doors (see page 7/8)
- 7 Flashing light
- 8 For above ground garages with a slope, a drainage channel in the driveway is recommended
- 9 In this area, 0% of downward/upward slope in longitudinal and cross direction

Dimensions

- all dimensions specified are the minimum, finished dimensions
- tolerances must be taken into consideration
- all dimensions are given in cm

Height dimensions

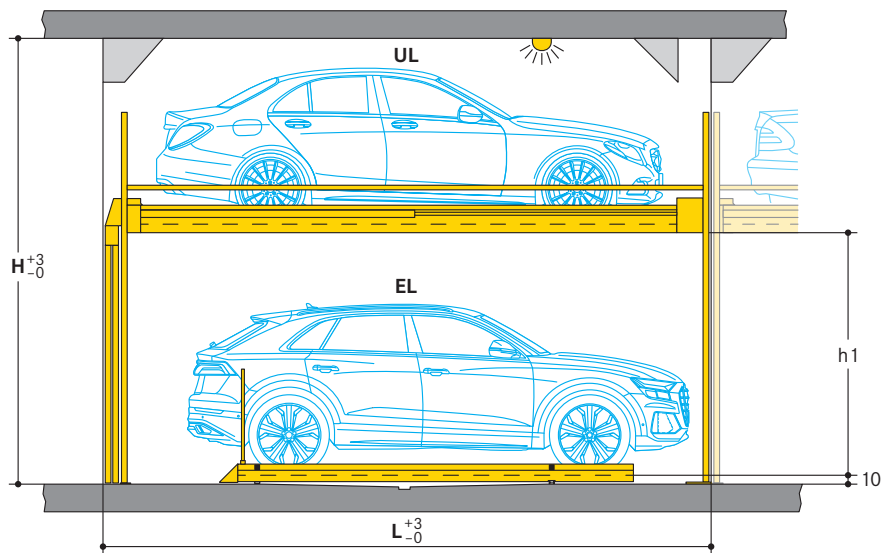

Type	Height h1	Vehicle height EL (entrance level)	Installation length L 1	Vehicle height UL (upper level)															
				150	155	160	165	170	175	180	185	190	195	200	205	210	215	220	
				Height H															
552-180	180	175	540 (560)	350	355	360	365	370	375	380	385	390	395	400	405	410	415	420	
552-185	185	180	540 (560)	355	360	365	370	375	380	385	390	395	400	405	410	415	420	425	
552-190	190	185	540 (560)	360	365	370	375	380	385	390	395	400	405	410	415	420	425	430	
552-195	195	190	540 (560)	365	370	375	380	385	390	395	400	405	410	415	420	425	430	435	
552-200	200	195	540 (560)	370	375	380	385	390	395	400	405	410	415	420	425	430	435	440	
552-205	205	200	540 (560)	375	380	385	390	395	400	405	410	415	420	425	430	435	440	445	
552-210	210	205	540 (560)	380	385	390	395	400	405	410	415	420	425	430	435	440	445	450	
552-215	215	210	540 (560)	385	390	395	400	405	410	415	420	425	430	435	440	445	450	455	
552-220	220	215	540 (560)	390	395	400	405	410	415	420	425	430	435	440	445	450	455	460	
552-225	225	220	560	395	400	405	410	415	420	425	430	435	440	445	450	455	460	465	

1 Installation length L 540 cm = vehicle length 500 cm. Installation length L 560 cm = vehicle length 520 cm.

Lower heights are possible but not recommended (please contact WÖHR).

Please see the table above:

For Combilift 552_MR: Different vehicle heights can be planned in the first row on the upper level and the entrance level. In the second, third and fourth row, the same vehicle heights must be planned for the upper level and the entrance level.

Example for passage height

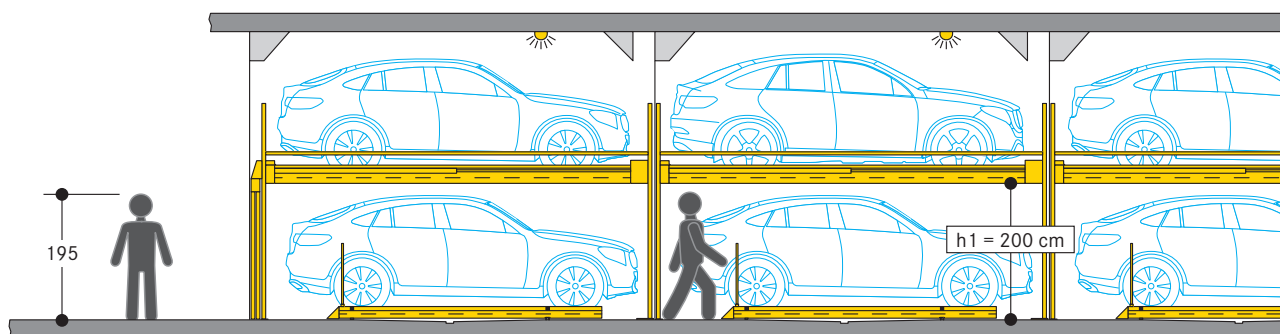

With a single system, we recommend a clear height h1 of at least 180 cm.

With two or more systems in a row, we recommend a clear height h1 of at least 200 cm.

Passenger car registrations in Germany

Orientation aid for height dimensions: With a system type from the table above, which for example covers cars up to 175 cm in height, 92.81 % of all cars registered in Germany can be parked.

Height	Examples of models	Passenger car registrations	
143,5	Opel Corsa	33,27 %	
144,1	VW Passat		
147,3	Audi A8		
161,5	VW ID.5	91,25 %	
166,8	BMW iX3		
168,1	Skoda Kodiaq		
171,2	Audi Q7	92,81 %	
171,8	Mercedes Benz EQS SUV		
172,7	Volvo XC90		
177,8	Ford Explorer	93,76 %	
179,7	Mercedes Benz GLE		
179,7	VW Caddy Kombi		
188,0	VW Amarok	99,27 %	
191,4	Land Rover Defender		
193,8	VW ID.Buzz		

* Due to different equipment, vehicles of the same design may have different heights. The maximum heights have been taken into account.

Source: German Federal Motor Transport Authority, 2022 (evaluation for motor vehicles registered in Germany for passenger transport with up to 9 seats).

Decision support for the vehicle height

Choosing the right vehicle height for your project is essentially based on any building regulations, user expectations and building specifications. Criteria can include:

Residential buildings:

Different parking space heights are conceivable and can affect the sales price. For example, lower parking spaces could be provided for higher vehicles. This results in more convenient access to the vehicle. Less high vehicles in the upper parking spaces and thus reduced building height and less enclosed space. The ramp to the underground car park will be less steep or less long. To make it easier to sell parking spaces, we recommend that the vehicle heights be the same.

Office buildings:

For this parking concept, we recommend the same vehicle height for all parking spaces. If permanently assigned parking spaces are preferred for parking permittees, different parking space heights could be provided.

Hotels:

Whether city hotel, vacation hotel or vacation apartments: With changing occupancy, all parking spaces should have the same vehicle height. Maximum parking space heights should be selected to allow parking for vehicles with roof-mounted structures, if necessary.

Configuration example residential buildings

1	Vehicle height UL	160 cm	3	Type	552-185
2	Vehicle height EL	180 cm	4	Height H	365 cm

Type	Height h1	Vehicle height EL (entrance level)	Vehicle height UL (upper level)														
			150	155	160	165	170	175	180	185	190	195	200	205	210	215	220
552-180	180	175	350	355	360	365	370	375	380	385	390	395	400	405	410	415	420
552-185	185	180	355	360	365	370	375	380	385	390	395	400	405	410	415	420	425
552-190	190	185	360	365	370	375	380	385	390	395	400	405	410	415	420	425	430

Configuration example office building and hotels

1	Vehicle height UL	205 cm	3	Type	552-210
2	Vehicle height EL	205 cm	4	Height H	435 cm

Type	Height h1	Vehicle height EL (entrance level)	Vehicle height UL (upper level)														
			150	155	160	165	170	175	180	185	190	195	200	205	210	215	220
552-205	205	200	375	380	385	390	395	400	405	410	415	420	425	430	435	440	445
552-210	210	205	380	385	390	395	400	405	410	415	420	425	430	435	440	445	450
552-215	215	210	385	390	395	400	405	410	415	420	425	430	435	440	445	450	455

Grid arrangement

To guarantee visibility and for safety reasons, please consider the following maximum grid arrangements.

WÖHR recommends: From 2 rows, platform width at least 280 cm.

1 row

Max. 15 grids

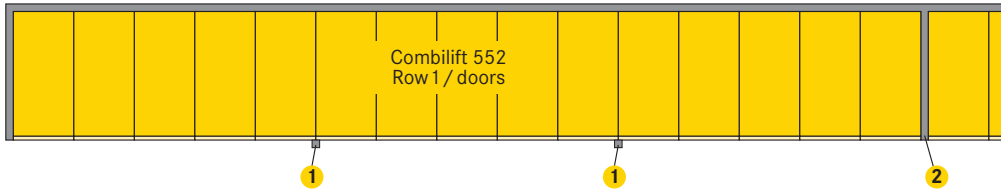

2 rows one behind the other

Max. 8 grids

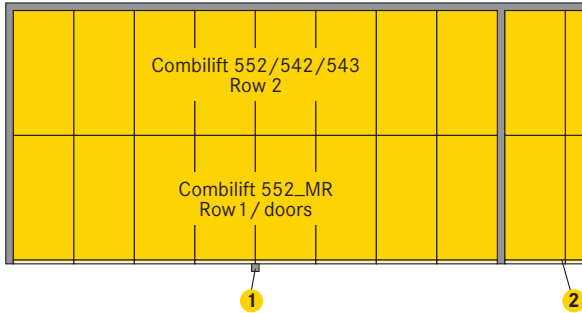

3 rows one behind the other

Max. 6 grids

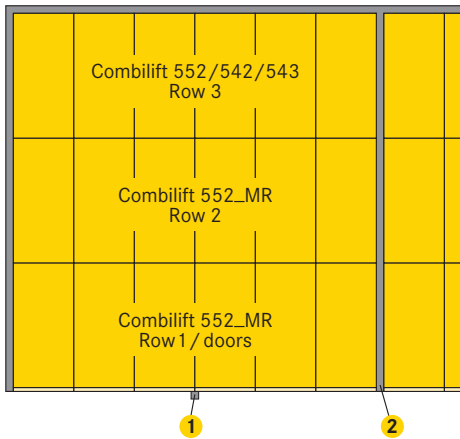

4 rows one behind the other

Max. 4 grids

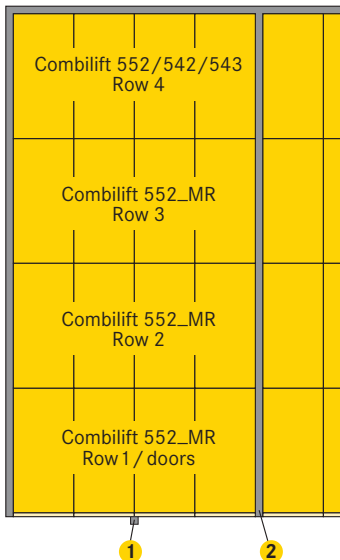

- 1** Operating device
- 2** Fixed walls or safety fences acc. to EN ISO 13857 or local requirement

■ Planning example: Combilift 552_MR/Combilift 552 one behind the other (vehicle length 500 cm)

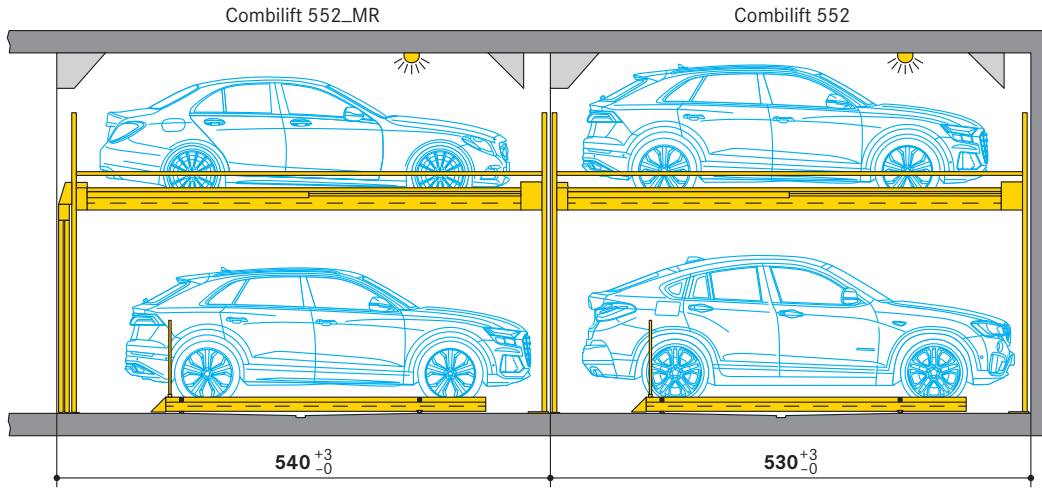

■ Planning example: Combilift 552_MR/Combilift 543 one behind the other (vehicle length 500 cm)

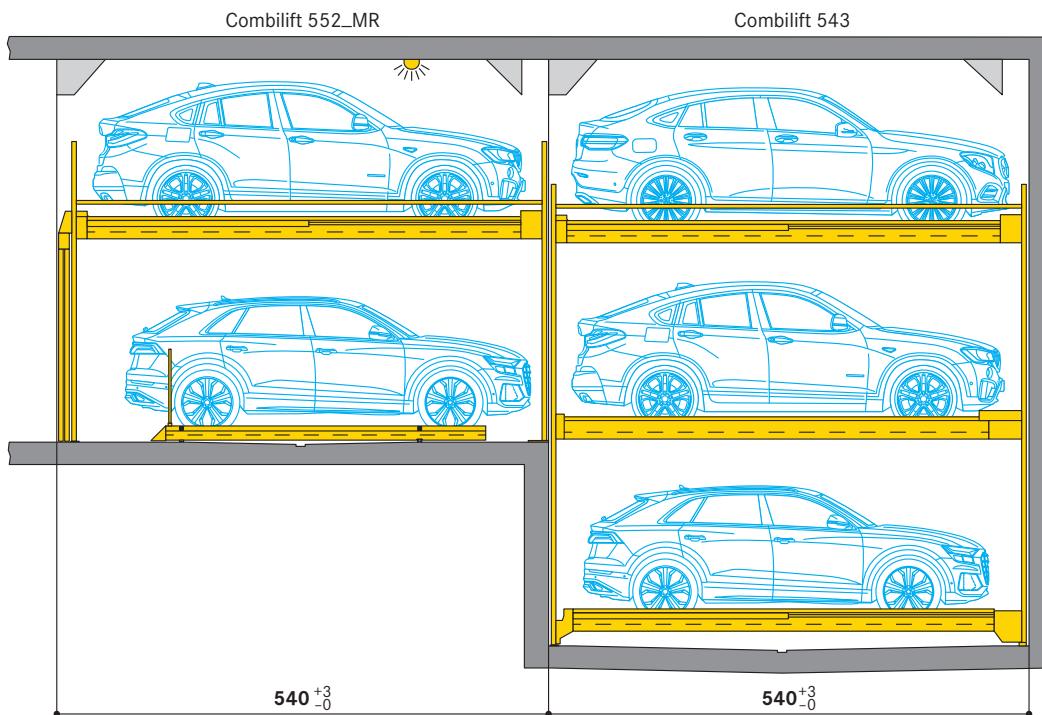

■ Planning example: Combilift 552_MR/Combilift 542 one behind the other (vehicle length 500 cm)

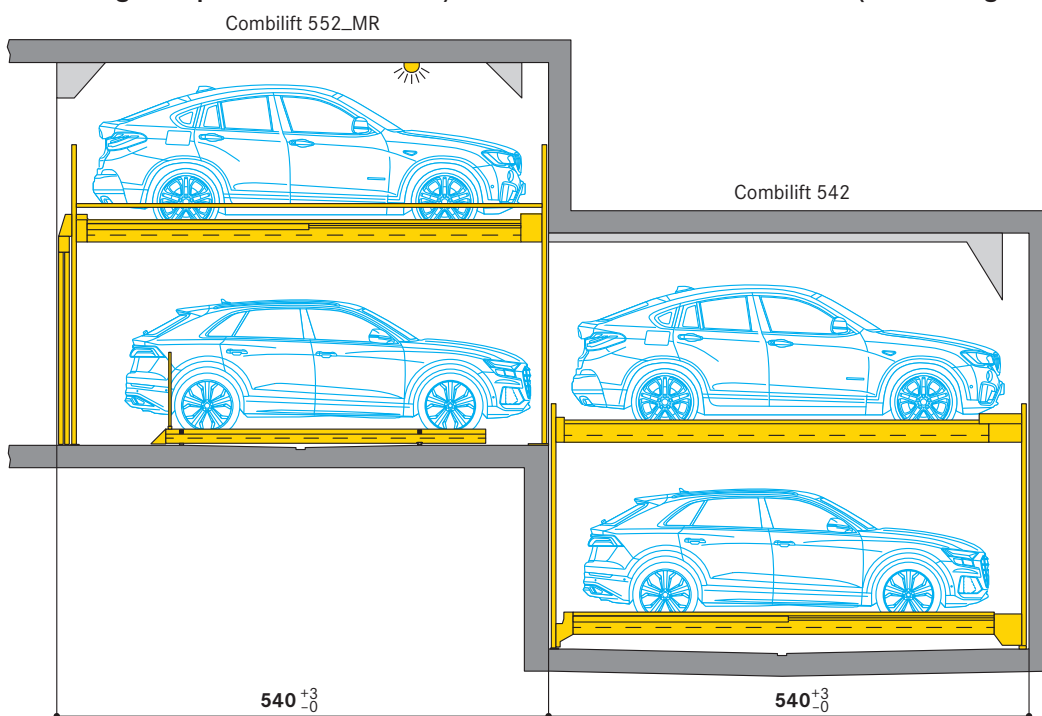

Clearance profile (for standard vehicles)

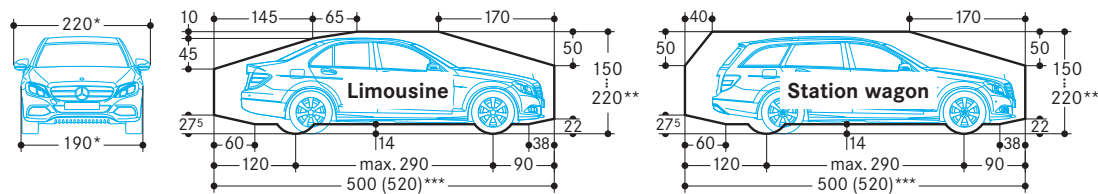

* for a 250 cm platform width
 ** The overall vehicle height including roof luggage rails and antenna mounts must not exceed the max. vehicle height dimensions specified
 *** see page 1

Width dimensions

Platform widths:

- 250 cm:
 - for 190 cm vehicle width (without outside mirror)
- 260–300 cm:
 - for vehicles wider than 190 cm (without outside mirror)
- 270–300 cm:
 - for units at the end of the driving aisle

For comfortable parking, entry and exit conditions platform widths upon 270 cm are recommended.

Reduced platform width means reduced parking comfort depending on the vehicle width, vehicle type, individual driving style, access situation of the (underground) garage.

With a 90° arrangement of the parking places, we recommend widening the driving aisle to at least 700 cm or a wall recess (see below).

Width dimensions (underground car park)

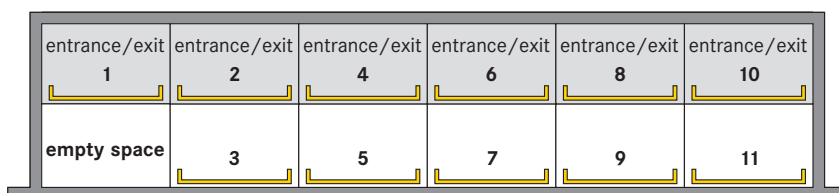

UL (upper level) 2
 EL (entrance level) 1 2

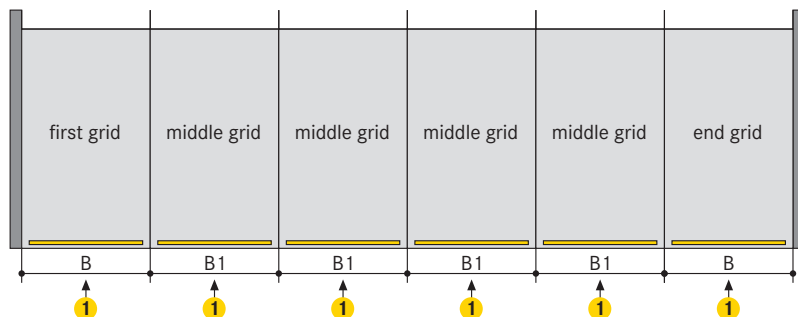

Space requirements		clear platform width upper level		clear platform width entrance level
B	B1	552	552_MR	552 552_MR
280	270	250	250	237
290	280	260	260	247
300	290	270	270	257
310	300	280 3	280 3	257
320	310	290 3	290 3	257
330	320	300 3	300 3	257

- 1 One entry/exit is required on entrance level (EL) for each grid
- 2 For a comfortable parking process and comfortable conditions for getting in and out of the car, we recommend platform widths of at least 270 cm. Smaller platform widths are possible but not recommended (please contact WÖHR).
- 3 Platform load max. 2600 kg
- 4 It is not possible to combine different platform widths

Door opening dimensions

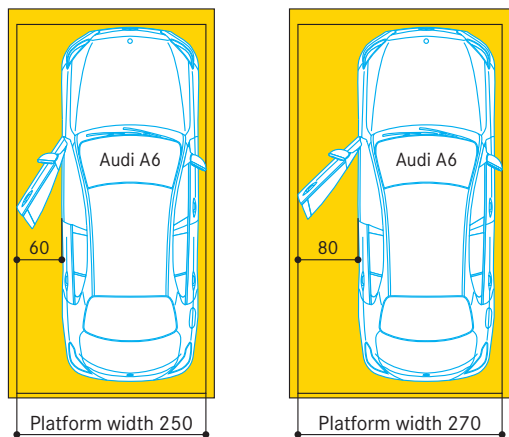

Depending on the vehicle model and the parking position of the vehicle on the platform, the space for opening the door varies. For comfortable conditions for getting in and out of the car, we recommend platform widths of at least 270 cm.

Wall recess

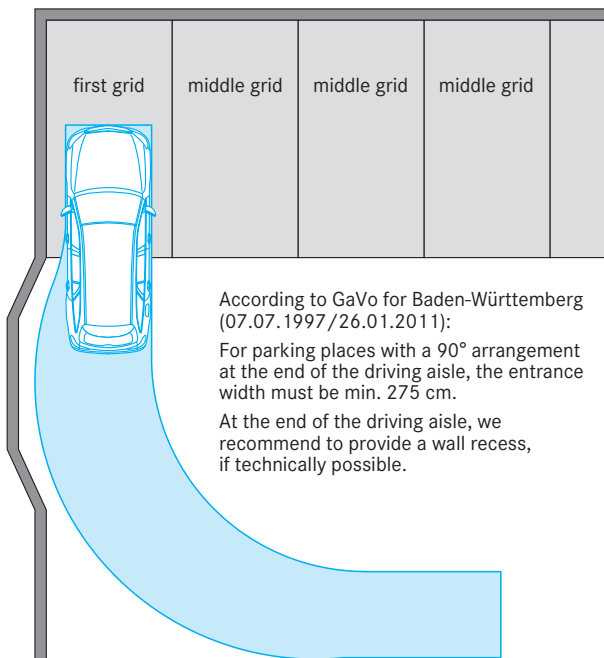

According to GaVo for Baden-Württemberg (07.07.1997/26.01.2011):
 For parking places with a 90° arrangement at the end of the driving aisle, the entrance width must be min. 275 cm.
 At the end of the driving aisle, we recommend to provide a wall recess, if technically possible.

Doors

According to DIN EN 14010 doors are required.

Automatic sliding doors:

- electrical drive
- controls are integrated in the overall system
- electro-mechanically interlocked
- can only be opened when the selected parking place has reached the entry/exit position
- any crash openings are closed in the entrance area

Local requirements for electrical doors regarding the technology, maintenance and revision are not subject of our delivery. These matters have to be observed and carried out by the customer, according to the local regulations.

Sliding doors behind the building pillars with door offset

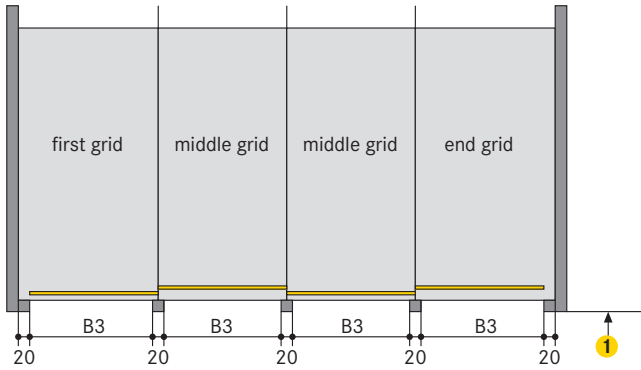

Space requirements B3	clear platform width
250	250
260	260
270	270
280	280 2
290	290 2
300	300 2

- 1 The driving aisle width must comply with local regulations
- 2 Platform load max. 2600 kg

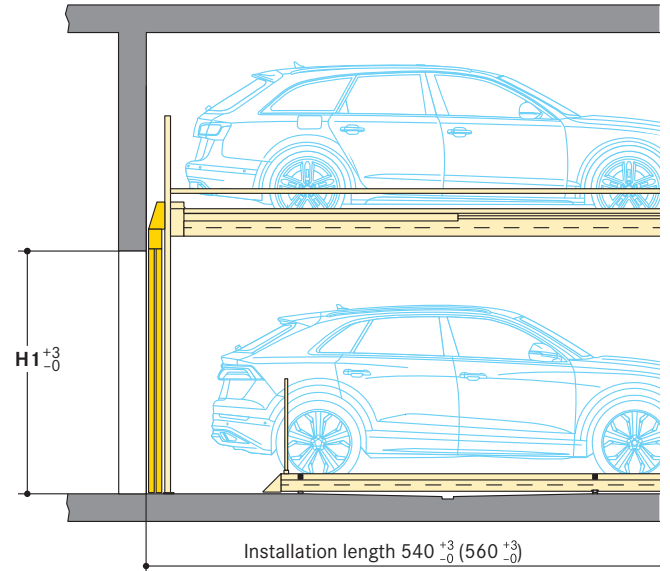

	Vehicle height UL (upper level) EL (entrance level)									
	175	180	185	190	195	200	205	210	215	220
H1	220	220	220	220	220	220	225	230	235	240

Sliding doors below the lintel between the building pillars

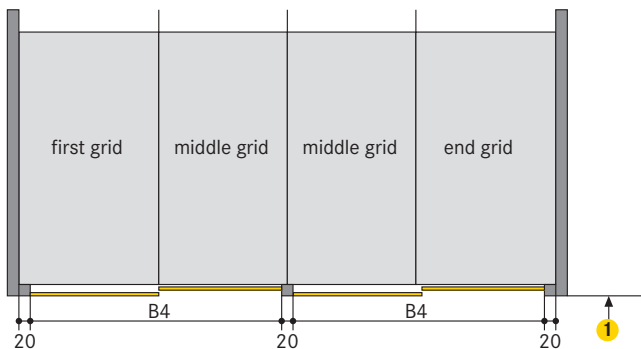

Space requirements B4	clear platform width
520	250
540	260
560	270
580	280 2
600	290 2
620	300 2

- 1 The driving aisle width must comply with local regulations
- 2 Platform load max. 2600 kg

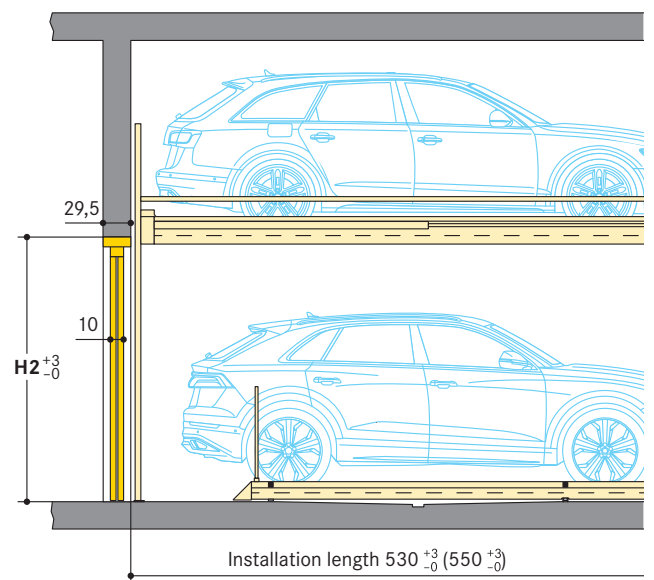

	Vehicle height UL (upper level) EL (entrance level)									
	175	180	185	190	195	200	205	210	215	220
H2	220	220	220	220	220	220	225	230	235	240

Sliding door floor guides

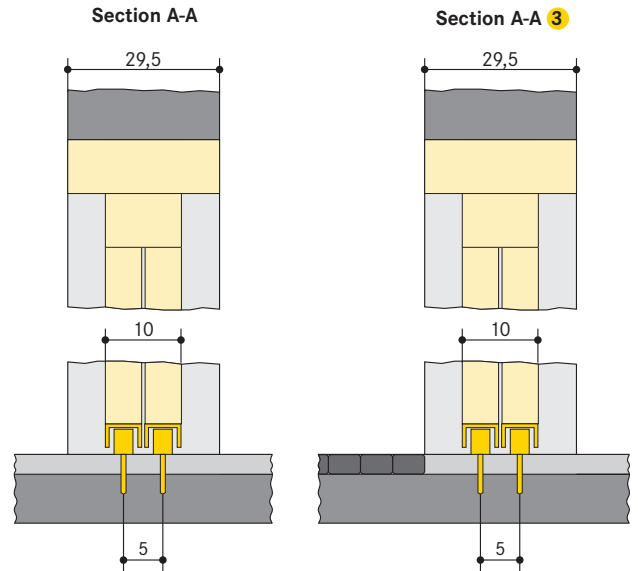
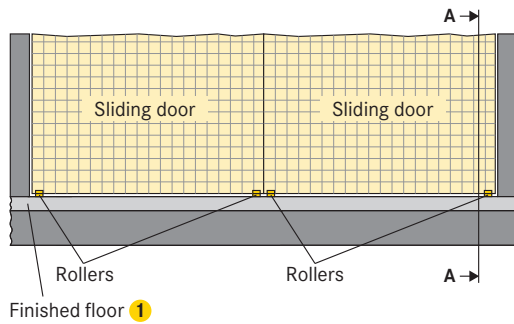

- 1** Finished floor:
 - compliant to DIN 18353,
 - floor evenness compliant to DIN 18202, table 3, line 3
- 2** Floor guide section:
 - base plate with plastic rollers
 - fixed on the floor with adhesive anchor (M8 internal screw thread)
 - borehole depth approx. 9 cm
 - in the event that floor filling needs to be laid into the door section to the purpose of reaching the required floor evenness, the borehole depth needs to be increased by the thickness of the floor fill (max. 4 cm)
- 3** If the driving aisle is made of concrete blocks, asphalt etc., the concrete slab in the door area must be min. 29,5 cm wide

Evenness and tolerances

In order to comply with the requirement and to obtain the necessary floor level, the tolerances of the evenness of the finished floor cannot be exceeded according to DIN 18202, table 3, line 3. Therefore, exact levelling of the floor by the customer is necessary.

Track and floor details

- Installation of the running rails:
- meter markers are to be permanently attached by the customer
 - do not use cast asphalt!
 - after bringing in the screed, the track rails are secured with adhesive anchors
 - level as per DIN 18202, table 3, line 3
 - no expansion gaps or building separation gaps are permitted in the area of the track system

For any subsequent installation of the parking platforms, in the parking area, an additional screed is to be taken into account by the customer, depending on the floor evenness.

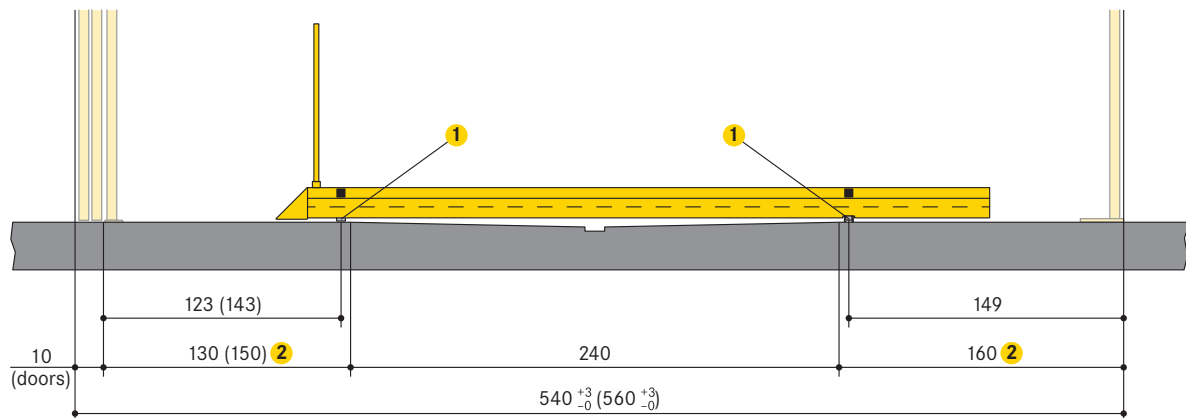

- 1** Running rail
- 2** In this area, 0% of downward/upward slope in longitudinal and cross direction

Static calculations and construction works requirement

Section

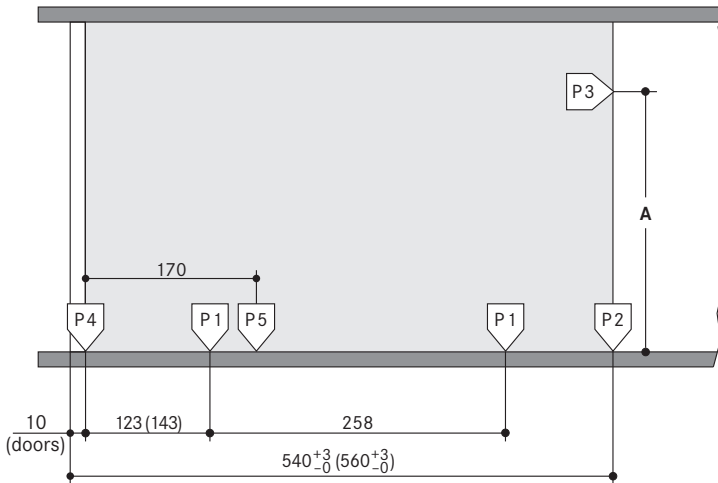

Type	A
552-180	288
552-185	293
552-190	298
552-195	303
552-200	308
552-205	313
552-210	318
552-215	323
552-220	328
552-225	333

Fixing of the system frames to the floor slab:

- using base plates (approx. 350 cm²)
- using adhesive anchor bolts
- hole depth to 12-14 cm
- bottom plate in concrete
- thickness of bottom plate min. 18 cm

Fixing of the system frames to the walls:

- with walls plates (approx. 30 cm²)
- using adhesive anchor bolts
- hole depth to 12-14 cm
- front drive-in wall and rear wall in concrete
- perfectly flat wall surfaces
- without protruding sections such as border edgings, pipes and tubes, etc.
- thickness of walls min. 18 cm

Concrete quality grade:

- compliant to the static requirements of the construction
- min. C20/25 grade (for dowel fastening)

Frame bearing points:

- the specified lengths are expressed as mean value
- for the exact data, specific TÜV-tested data sheets are available

Door widths/widths of columns:

- please contact WÖHR
- grid width (270/280/290/300/310/320) must be observed

552 552_MR (2000 kg)	
P1	+ 12,0 kN*
P2	+ 10,0 kN
P3	± 1,5 kN
P4	+ 9,0 kN
P5	± 1,5 kN

552 552_MR (2600 kg)	
P1	+ 14,0 kN*
P2	+ 12,0 kN
P3	± 1,8 kN
P4	+ 11,0 kN
P5	± 1,8 kN

552 552_MR (3000 kg)	
P1	+ 16,0 kN*
P2	+ 14,0 kN
P3	± 2,0 kN
P4	+ 13,0 kN
P5	± 2,0 kN

*specified load bearing data includes the vehicle weight

Ground plan

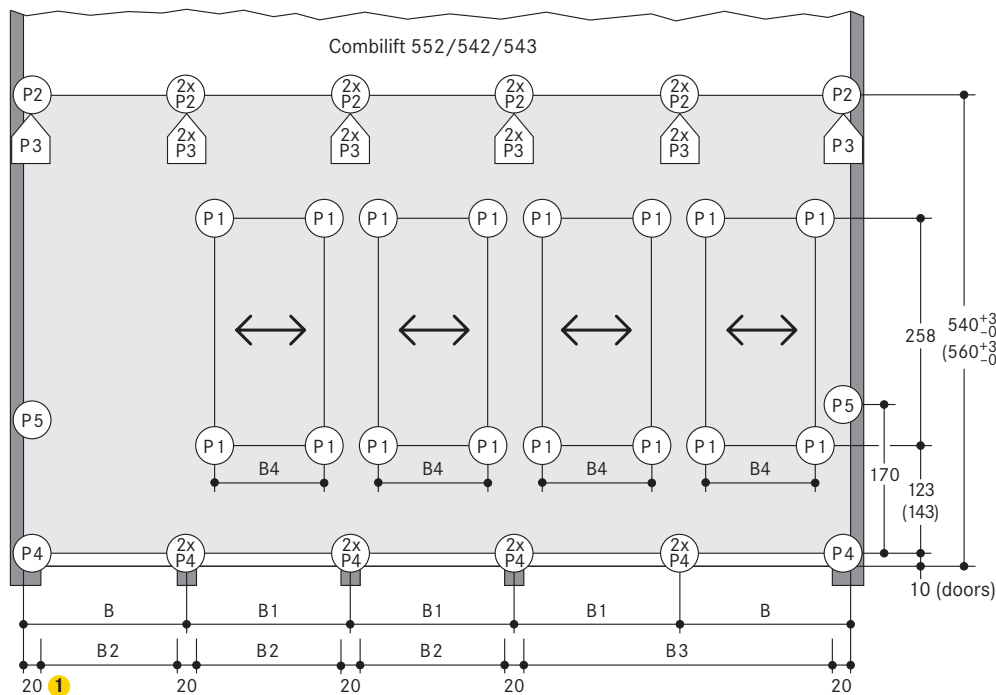

Space requirements				clear platform width entrance level B4	clear platform width upper level
B	B1	B2	B3		
280	270	250	520	237	250
290	280	260	540	247	260
300	290	270	560	257	270
310	300	280	580	257	280 2
320	310	290	600	257	290 2
330	320	300	620	257	300 2

1 If the width of the pillars is more than 20 cm, than the width of the drive through will be reduced accordingly to the above mentioned width dimensions (B and B1). In order to avoid this, we recommend to extend the measures between the pillars (B2 and B3) accordingly. Please contact WÖHR.

2 Platform load max. 2600 kg

Electrical specifications

Installation diagram

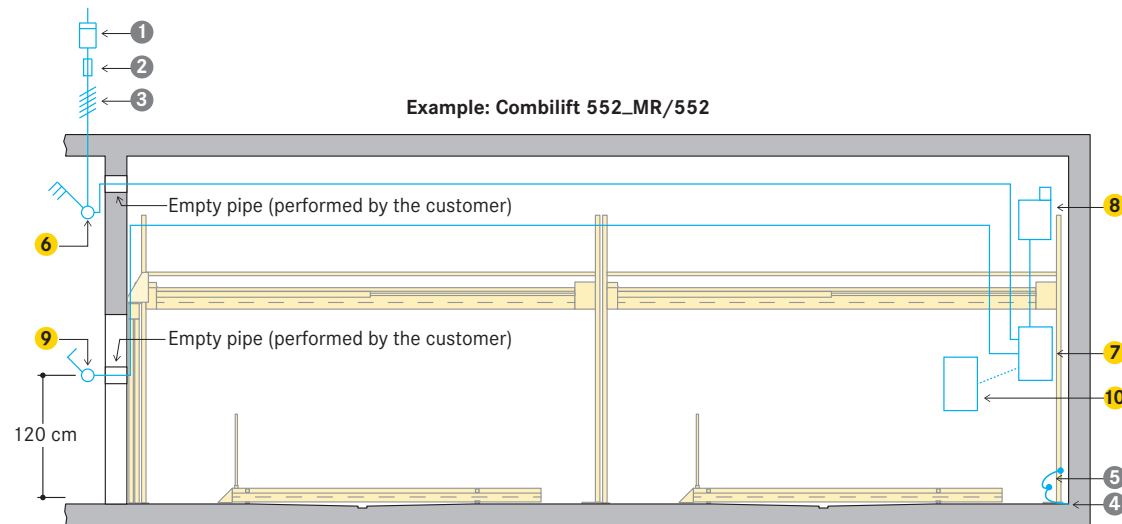

Cabling preparation to be performed by the customer:

- up to the main switch to be in place prior to starting the installation operations
- connection to the main switch during installation
- system functional check testing can be performed by WÖHR together with the electrician provided by the customer
- if requested at a later date, functional check testing can be performed by WÖHR at extra-cost

Grounding and potential equalisation (to be performed by the customer):

- compliant to DIN EN 60204
- connections required every 10 metres

To be performed by the customer

Item	Quantity	Description	Position	Recurrence				
1	1 piece	Power meter	In the feed cable					
2	1 piece	Fuse protection or automatic circuit breaker:*	In the feed cable	1 x per system				
		Rows			Motor	Starting current	Fuse protection	Platform load
		1			3,0 kW	24 A	3 x 16 A (11 kW)	2000 kg/2600 kg
		2			3,0 kW	48 A	3 x 32 A (22 kW)	2000 kg/2600 kg
		3			3,0 kW	72 A	3 x 40 A (28 kW)	2000 kg/2600 kg
		4			3,0 kW	96 A	3 x 63 A (44 kW)	2000 kg/2600 kg
		1			5,5 kW	57 A	3 x 32 A (22 kW)	3000 kg
		2			5,5 kW	114 A	3 x 63 A (44 kW)	3000 kg
3	5,5 kW	171 A	3 x 100 A (69 kW)	3000 kg				
4	5,5 kW	228 A	3 x 125 A (86 kW)	3000 kg				
3	Based on site conditions	Compliant to local power supply regulations 3 phases + N + PE* 230/400 V, 50 Hz	Feed cables to main switch including connection	1 x per system				
4	Every 10 m	Grounding and potential equalisation lead-out connection	Along floor edges/rear wall					
5	1 piece	Grounding and potential equalisation compliant to DIN EN 60204	From lead-out connection to system	1 x per system				

* Compliant to DIN VDE 0100 sections 410 and 430 (no permanent load) 3 phases + N+ PE (three phase current)

Scope of delivery by WÖHR (unless otherwise specified in the order)

Item	Description
6	Lockable main switch
7	Main switch cabinet for grid 1-4
8	Hydraulic power pack 3.0 kW (5.5 kW for platform load 3000 kg) with three-phase motor. Ready-wired switching cabinet with motor safety contactor
9	Branch connector
10	Operating device
11	Extra switch cabinet for grid 5-8

Notes and directions

Scope of application

- suitable for residential buildings, office buildings and business premises, hotels
- only for long-term users that have been instructed on how to use the system
- for frequently changing users (e.g. for office, hotel and business premises or similar):
 - performance of technical system adjustments is necessary
 - please consult with WÖHR

Function

- one empty space per unit on entrance level
- platforms on entrance level are moved sideways
- platforms on the upper level are lowered to the empty space on the entrance level

Numbering of the parking places

- empty space on the entrance level on the left
- numbering single system:

1	2	4	6	8
-	3	5	7	9

Combilift 552

- numbering installation for driving through:

6	7	9	11	12	14	16	17	19	Combilift 552 (542/543)
-	8	10	-	13	15	-	18	20	
1	2	4	6	7	9	11	12	14	Combilift 552_MR
-	3	5	-	8	10	-	13	15	
	1	2	4	6	7	9	10		Combilift 552_MR
	-	3	5	-	8	10			
	1	2	4	6	7	9	10		Combilift 552_MR
	-	3	5	-	8	10			

- the numbering for each unit starts with 1
- different numbering of parking places is possible at extra cost (software changes are necessary)

Hydraulic power pack

- Arrangement of the hydraulic power pack:
- within the unit

Noise protection

Basis is the German DIN 4109 "Noise protection in buildings".
 With the following conditions required 30 dB (A) in rooms can be provided:

- noise protection package from our accessory
- insulation figure of the construction of min. $R'_w = 57$ dB
- walls which are bordering the parking systems must be done as single wall and deflection resistant with min. $m' = 300$ kg/m²
- solid ceiling above the parking systems with min. $m' = 400$ kg/m²

At differing constructional conditions additional sound absorbing measures are to be provided by the customer.

The best results are reached by separated sole plates from the construction.

Increased sound insulation (separate agreement):

It is based on VDI 4100 „Sound insulation in building construction“ Assessment and proposals for increased sound insulation.

Under the following conditions, 25 dB (A) can be complied with in living spaces and bedrooms:

- sound insulation package according to offer/order
- Sound insulation value of the building structure of min. $R'_w = 62$ dB (to be performed by the customer)

Note:

User noises are not subject to the requirements (see VDI 4100, Scope - Notes). User noises are basically noises that can be individually influenced by the user of the parking systems (e.g. driving on the platform, closing of vehicle doors, engine and brake noises).

Temperature

- system operating range: +5° bis +40°C (with unloaded platforms and low temperatures, a reduced lowering speed is to be expected)
- humidity: 50 % at +40° C
- if use in deviating temperature ranges is planned, constructive adjustments may be necessary (please consult with WÖHR)

Conformity examination (TÜV)



- voluntary conformity assessment by the TÜV SÜD
- The parking systems are compliant to:
 - EC Machinery Directive 2006/42/EC
 - DIN EN 14010
 - Specification VDMA 15423

Switch cabinet

- Arrangement of the switch cabinet:
- within the unit

Lighting

- sufficient lighting of the driving aisle and of the parking places must be performed by the customer

Fire safety

- all fire safety requirements and all mandatory equipment (fire extinguisher and fire alarm systems, etc.) must be performed by the customer
- WÖHR will provide documents on attachment points and clearances for sprinklers on request

Railings

If walkways are arranged directly to the side or behind the systems, railings have to be provided by the customer acc. to local requirements, height min. 200 cm - this is applicable during the construction phase too.

Maintenance

- WÖHR and all the WÖHR partners abroad provide an installation and customer service network
- regular, annual maintenance is provided subject to the stipulation of a maintenance agreement
- local requirements for electrical doors regarding the technology, maintenance and revision are not subject of our delivery. These matters have to be observed and carried out by the customer, according to the local regulations.

Prevention of corrosion damage



- all operations listed in the WÖHR Cleaning and Maintenance Instructions are to be performed regularly (independently of maintenance operations)
- zinc-plated parts, components and platforms are to be kept clean of dirt, road-salt and any other debris (due to corrosion hazards)
- always keep the garage well ventilated and deaerated

Surface protection



- please consider the information on surface protection!

Tender specification



- please consider the specifications!

Parking Place-Profile



- please consider the product information Parking Place-Profile!

Electromobility



- please consider the product information power supply!
- depending on the position of the charging point on the electric vehicle, collision points with protruding plugs and charging cables can occur

Sliding doors and Operating concepts



- please consider the product information Sliding doors and Operating concepts!

Construction formalities

- the documentation necessary for construction permit applications is provided by WÖHR on demand

Construction alterations and/or modifications

- the right to construction or model modifications and/or variations is hereby reserved
- the right to any subsequent part modification and/or variation and amendments in procedures and standards due to technical and engineering progresses or due to environmental regulation changes is also hereby reserved