

Data Sheet

WÖHR COMBILIFT 542/542_MR

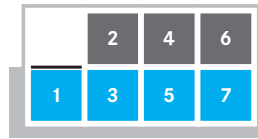

- **Combilift 542: single system**
- **Combilift 542_MR: for driving through to reach a rear parking in combination with:**
– Combilift 552, 542, 543
- **Platform load options:**
 - max. 2000 kg, load per wheel 500 kg
 - max. 2600 kg, load per wheel 650 kg **1**
 - max. 3000 kg, load per wheel 750 kg **1**
- **Platform load can be increased later (also individual parking places)**
- **Platforms are in horizontal position to drive on**
- **Arrangement from 2 grids**



With MR-systems: you can drive into the rear system via the empty space.

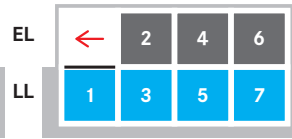

Or the parking places 2 and 4 are shifted to the left.

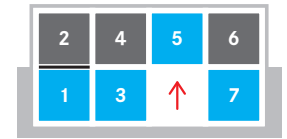

A lower parking place can be lifted up.

Length dimensions underground car park (height dimensions see page 6/7)

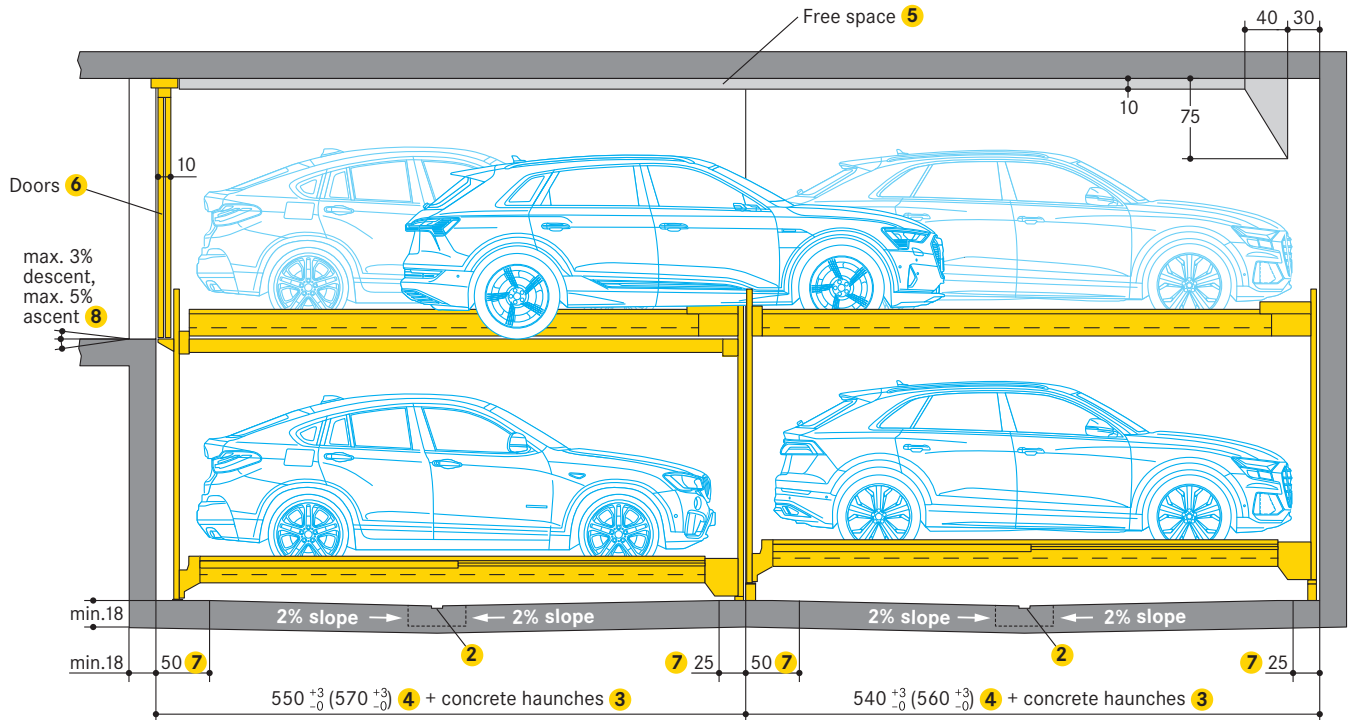

- 1** Increasing of platform load at extra cost
- 2** Drainage channels (performed by the customer):
– 10 x 2 cm, with a 50 x 50 x 20 cm drainage pit
– in case of installation of a sump pump, it is necessary to comply with the drainage pit dimensions specified by the pump manufacturer
- 3** Channels or undercuts/concrete haunches (performed by the customer):
– not allowed along the pit floor-to-wall joints
– should channels or undercuts be necessary, the system width needs to be reduced or the pit needs to be wider
- 4** 500 cm vehicle length = 550/540 cm pit length (including doors)
520 cm vehicle length = 570/560 cm pit length (including doors)
For MR-systems:
– pit depth 250 and 255: pit length +10 cm
– pit depth 260: pit length +20 cm
Due to the increasing length of vehicles, we recommend a pit length of 570 cm in order to be able to park mid-range models in the future.
- 5** Free spaces:
– please ask WÖHR for the dimension sheets
- 6** Doors (see page 13/14)
- 7** In this area, 0% of downward/upward slope in longitudinal and cross direction
- 8** For above ground garages with a slope, a drainage channel in the driveway is recommended

■ Dimensions

- all dimensions specified are the minimum, finished dimensions
- tolerances must be taken into consideration
- all dimensions are given in cm

■ **Differentiation Combilift 542 and Combilift 542_MR**

The **Combilift 542** is used in a 1-row system and in a multi-row arrangement in the last row.
 The **Combilift 542_MR** is used for multi-row arrangements in the front row

■ **1 row**

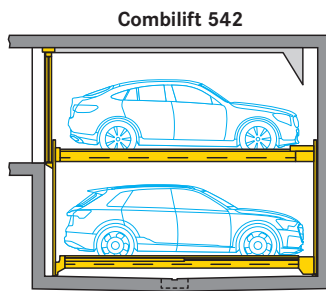

■ **2 rows**

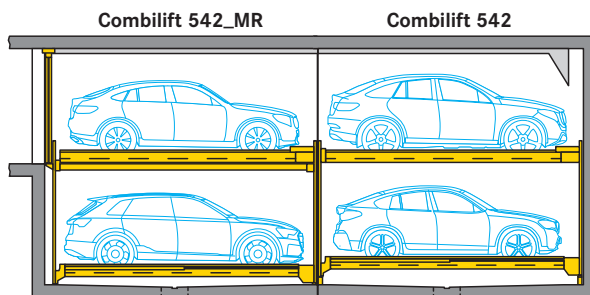

■ **3 rows**

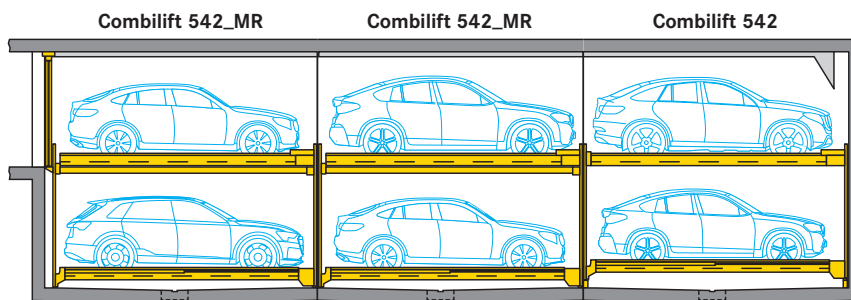

■ **4 rows**

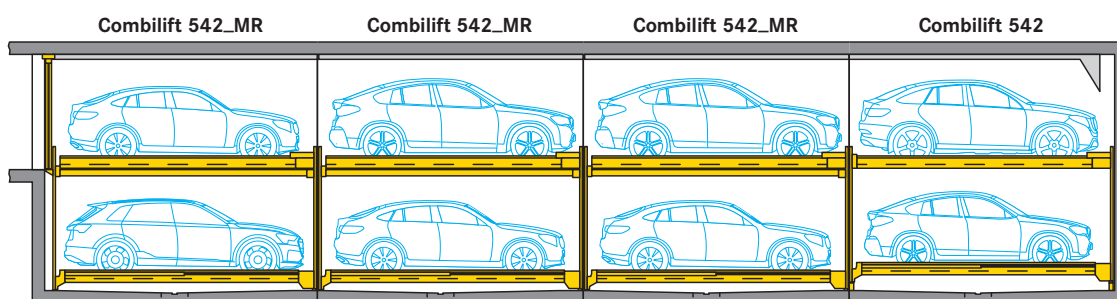

Grid arrangement and combinations for multi-row systems

To guarantee visibility and for safety reasons, please consider the following maximum grid arrangement.

WÖHR recommends: Platform width at least 280 cm.

2 rows one behind the other

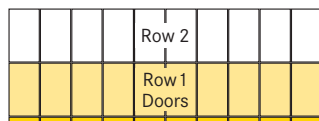

Combilift 542
max. 10 grids, 19 parking places

Combilift 542_MR
max. 10 grids, 19 parking places

Combilift 543
max. 10 grids, 29 parking places

Combilift 552
max. 10 grids, 19 parking places

Combination Combilift 542_MR with Combilift 542

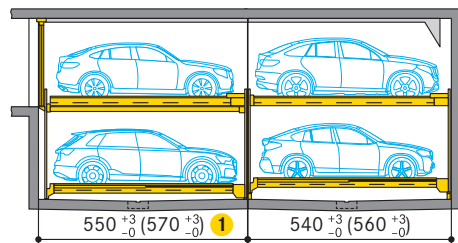

WÖHR recommends:
max. 9 grids, 34 parking places

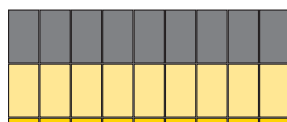

Combilift 542
9 grids, 17 parking places

Combilift 542_MR
9 grids, 17 parking places

Combination Combilift 542_MR with Combilift 543

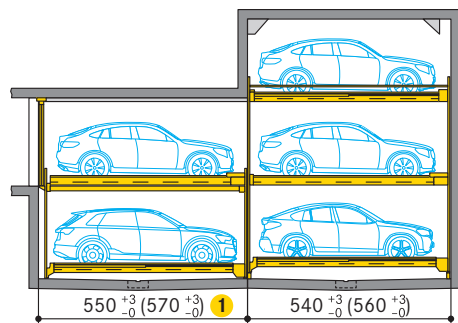

WÖHR recommends:
max. 7 grids, 33 parking places

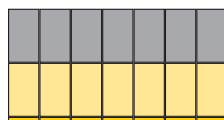

Combilift 543
7 grids, 20 parking places

Combilift 542_MR
7 grids, 13 parking places

Combination Combilift 542_MR with Combilift 552

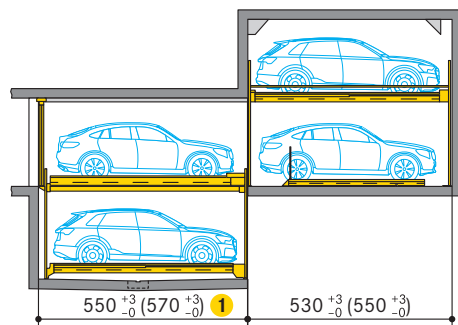

WÖHR recommends:
max. 9 grids, 34 parking places

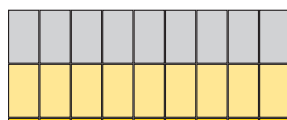

Combilift 552
9 grids, 17 parking places

Combilift 542_MR
9 grids, 17 parking places

- 1 Pit depth 250 and 255: +10 cm
Pit depth 260: +20 cm

Grid arrangement and combinations for multi-row systems

To guarantee visibility and for safety reasons, please consider the following maximum grid arrangement.

WÖHR recommends: Platform width at least 280 cm.

3 rows one behind the other

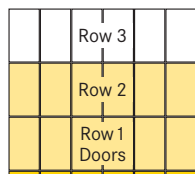

Combilift 542
max. 6 grids, 11 parking places

Combilift 543
max. 6 grids, 17 parking places

Combilift 552
max. 6 grids, 11 parking places

Combilift 542_MR
max. 6 grids, 11 parking places

Combilift 542_MR
max. 6 grids, 11 parking places

Combination Combilift 542_MR with Combilift 542

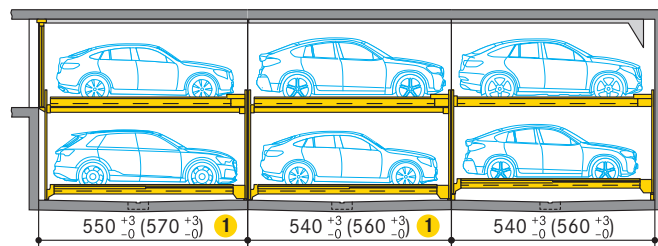

WÖHR recommends:
max. 6 grids, 33 parking places

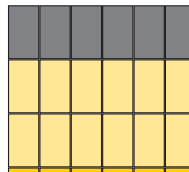

Combilift 542
6 grids, 11 parking places

Combilift 542_MR
6 grids, 11 parking places

Combilift 542_MR
6 grids, 11 parking places

Combination Combilift 542_MR with Combilift 543

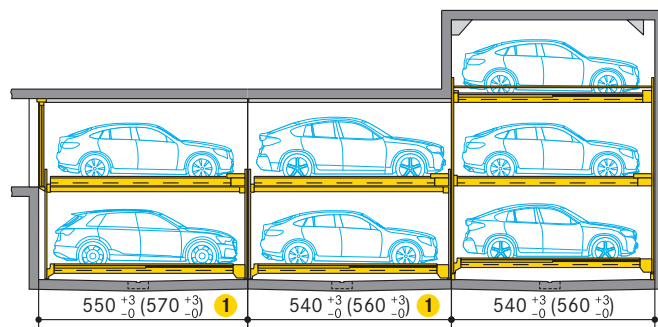

WÖHR recommends:
max. 5 grids, 32 parking places

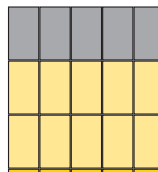

Combilift 543
5 grids, 14 parking places

Combilift 542_MR
5 grids, 9 parking places

Combilift 542_MR
5 grids, 9 parking places

Combination Combilift 542_MR with Combilift 552

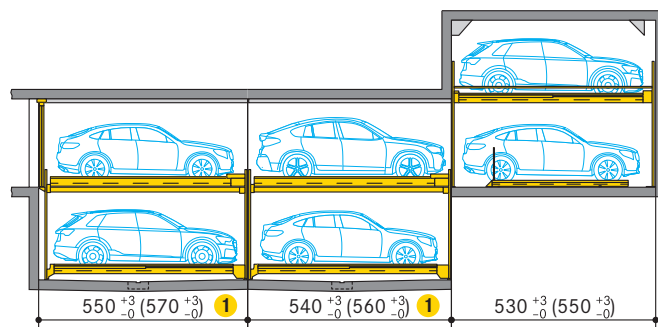

WÖHR recommends:
max. 6 grids, 33 parking places

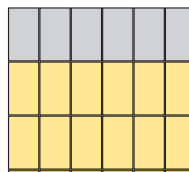

Combilift 552
6 grids, 11 parking places

Combilift 542_MR
6 grids, 11 parking places

Combilift 542_MR
6 grids, 11 parking places

1 Pit depth 250 and 255: +10 cm
Pit depth 260: +20 cm

Grid arrangement and combinations for multi-row systems

To guarantee visibility and for safety reasons, please consider the following maximum grid arrangement.

WÖHR recommends: Platform width at least 280 cm.

4 rows one behind the other

Row 4	Combilift 542 max. 4 grids, 7 parking places	Combilift 543 max. 4 grids, 11 parking places	Combilift 552 max. 4 grids, 7 parking places
Row 3	Combilift 542_MR max. 4 grids, 7 parking places		
Row 2	Combilift 542_MR max. 4 grids, 7 parking places		
Row 1 Doors	Combilift 542_MR max. 4 grids, 7 parking places		

Combination Combilift 542_MR with Combilift 542

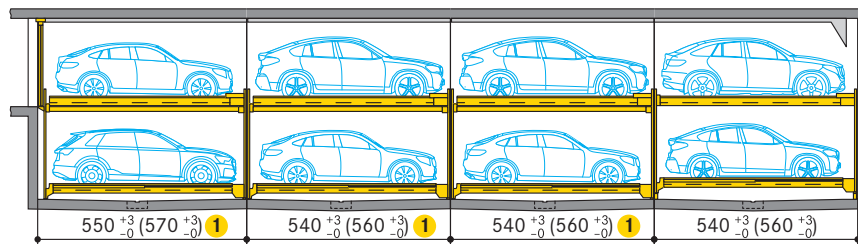

WÖHR recommends:
max. 4 grids, 28 parking places

				Combilift 542 4 grids, 7 parking places
				Combilift 542_MR 4 grids, 7 parking places
				Combilift 542_MR 4 grids, 7 parking places
				Combilift 542_MR 4 grids, 7 parking places

Combination Combilift 542_MR with Combilift 543

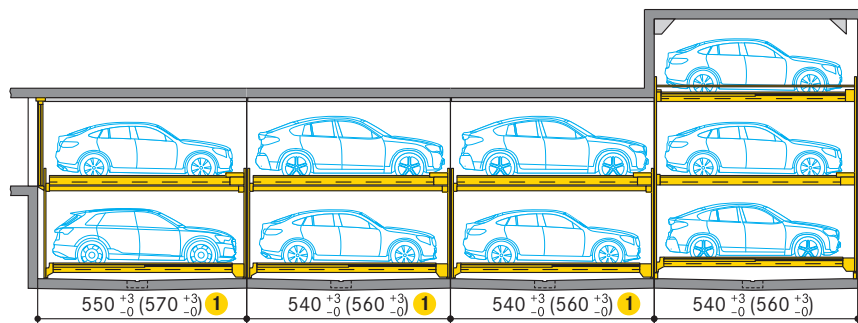

WÖHR recommends:
max. 4 grids, 32 parking places

				Combilift 543 4 grids, 11 parking places
				Combilift 542_MR 4 grids, 7 parking places
				Combilift 542_MR 4 grids, 7 parking places
				Combilift 542_MR 4 grids, 7 parking places

Combination Combilift 542_MR with Combilift 552

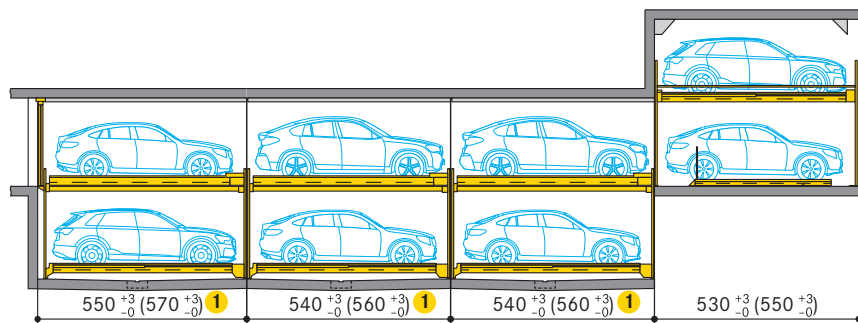

WÖHR recommends:
max. 4 grids, 28 parking places

				Combilift 552 4 grids, 7 parking places
				Combilift 542_MR 4 grids, 7 parking places
				Combilift 542_MR 4 grids, 7 parking places
				Combilift 542_MR 4 grids, 7 parking places

- 1 Pit depth 250 and 255: +10 cm
Pit depth 260: +20 cm

Height dimensions Combilift 542

See page 8 for examples of configuration.

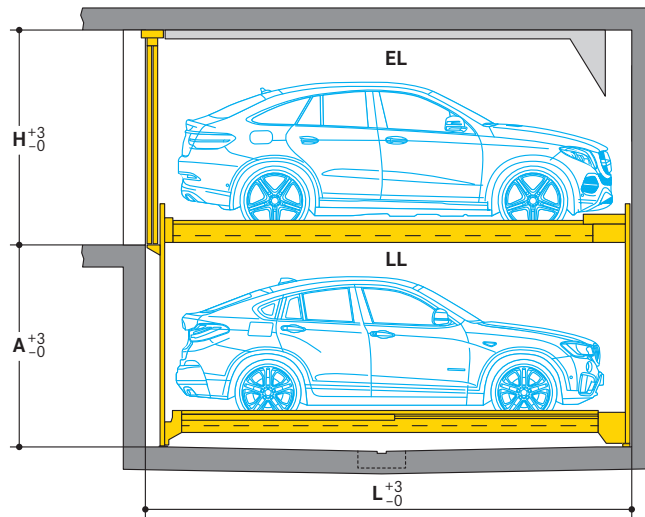

Type	Pit depth A	Vehicle height LL (lower level)	Pit length L ①	Vehicle height EL (entrance level)				
				200	205	210	215	220
				Height H				
542-175	175	150	550 (570)	220	225	230	235	240
542-180	180	155	550 (570)	220	225	230	235	240
542-185	185	160	550 (570)	220	225	230	235	240
542-190	190	165	550 (570)	220	225	230	235	240
542-195	195	170	550 (570)	220	225	230	235	240
542-200	200	175	550 (570)	220	225	230	235	240
542-205	205	180	550 (570)	220	225	230	235	240
542-210	210	185	550 (570)	220	225	230	235	240
542-215	215	190	550 (570)	220	225	230	235	240
542-220	220	195	550 (570)	220	225	230	235	240
542-225	225	200	550 (570)	220	225	230	235	240
542-230	230	205	550 (570)	-	225	230	235	240
542-235	235	210	550 (570)	-	-	230	235	240
542-240	240	215	550 (570)	-	-	-	235	240
542-245	245	220	550 (570)	-	-	-	-	240

① Dimensions in brackets for vehicle length 520 cm

Market shares by vehicle height

The following list is intended as a guide to help you select the platform distance and construction dimensions:

Examples of models	Height	Market shares
Opel Corsa	143,5	<p>up to 150 cm*</p>
VW Passat	144,1	
Audi A8	147,3	
VW ID.5	161,5	<p>up to 170 cm*</p>
BMW iX3	166,8	
Skoda Kodiaq	168,1	
Audi Q7	171,2	<p>up to 175 cm*</p>
Mercedes Benz EQS SUV	171,8	
Volvo XC90	172,7	
Ford Explorer	177,8	<p>up to 180 cm*</p>
Mercedes Benz GLE	179,7	
VW Caddy Kombi	179,7	
VW Amarok	188,0	<p>up to 205 cm*</p>
Land Rover Defender	191,4	
VW ID.Buzz	193,8	

* Due to different equipment, vehicles of the same design may have different heights. The maximum heights have been taken into account.

Source: German Federal Motor Transport Authority, 2022 (evaluation for motor vehicles registered in Germany for passenger transport with up to 9 seats).

Height dimensions Combilift 542_MR

See page 8 for examples of configuration.

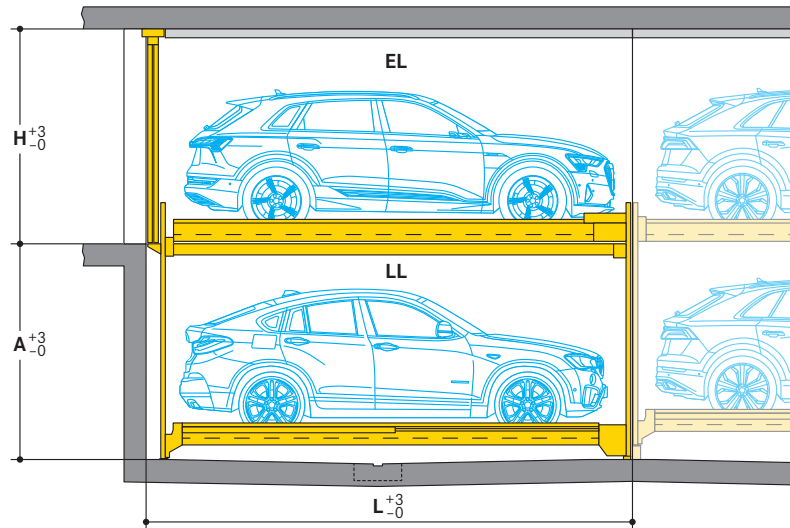

Type	Pit depth A	Vehicle height LL (lower level)	Pit length L ¹	Vehicle height EL (entrance level)				
				200	205	210	215	220
				Height H				
542_MR-190	190	150	550 (570)	220	225	230	235	240
542_MR-195	195	155	550 (570)	220	225	230	235	240
542_MR-200	200	160	550 (570)	220	225	230	235	240
542_MR-205	205	165	550 (570)	220	225	230	235	240
542_MR-210	210	170	550 (570)	220	225	230	235	240
542_MR-215	215	175	550 (570)	220	225	230	235	240
542_MR-220	220	180	550 (570)	220	225	230	235	240
542_MR-225	225	185	550 (570)	220	225	230	235	240
542_MR-230	230	190	550 (570)	220	225	230	235	240
542_MR-235	235	195	550 (570)	220	225	230	235	240
542_MR-240	240	200	550 (570)	220	225	230	235	240
542_MR-245	245	205	550 (570)	-	225	230	235	240
542_MR-250	250	210	560 (580)	-	-	230	235	240
542_MR-255	255	215	560 (580)	-	-	-	235	240
542_MR-260	260	220	570 (590)	-	-	-	-	240

¹ Dimensions in brackets for vehicle length 520 cm

Decision support for the vehicle height

Choosing the right vehicle height for your project is essentially based on any building regulations, user expectations and building specifications. Criteria can include:

Residential buildings:

Different parking space heights are conceivable and can affect the sales price. For example, lower parking spaces could be provided for higher vehicles. This results in more convenient access to the vehicle. Less high vehicles in the upper parking spaces and thus reduced building height and less enclosed space. The ramp to the underground car park will be less steep or less long. To make it easier to sell parking spaces, we recommend that the vehicle heights be the same.

Office buildings:

For this parking concept, we recommend the same vehicle height for all parking spaces. If permanently assigned parking spaces are preferred for parking permittees, different parking space heights could be provided.

Hotels:

Whether city hotel, vacation hotel or vacation apartments: With changing occupancy, all parking spaces should have the same vehicle height. Maximum parking space heights should be selected to allow parking for vehicles with roof-mounted structures, if necessary.

Configuration example residential buildings

1	Vehicle height EL	205 cm	3	Type	542_MR-205
2	Vehicle height LL	165 cm	4	Pit depth A	205 cm
			5	Height H	225 cm

Type	Pit depth A	Vehicle height LL (lower level)	1 Vehicle height EL (entrance level)				
			200	205	210	215	220
			Height H				
3 542_MR-200	4 200	2 160	220	5 225	230	235	240
542_MR-205	205	165	220	225	230	235	240
542_MR-210	210	170	220	225	230	235	240

Configuration example office building and hotels

1	Vehicle height EL	205 cm	3	Type	542_MR-245
2	Vehicle height LL	205 cm	4	Pit depth A	245 cm
			5	Height H	225 cm

Type	Pit depth A	Vehicle height LL (lower level)	1 Vehicle height EL (entrance level)				
			200	205	210	215	220
			Height H				
3 542_MR-240	4 240	2 200	220	5 225	230	235	240
542_MR-245	245	205	-	225	230	235	240
542_MR-250	250	210	-	-	230	235	240

Pit dimensions without intermediate walls

Straight pit:

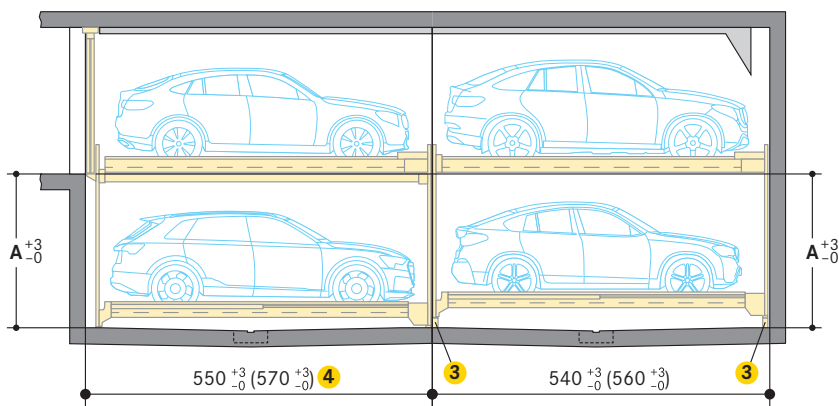

Stepped pit:

- without extra costs for Combilift

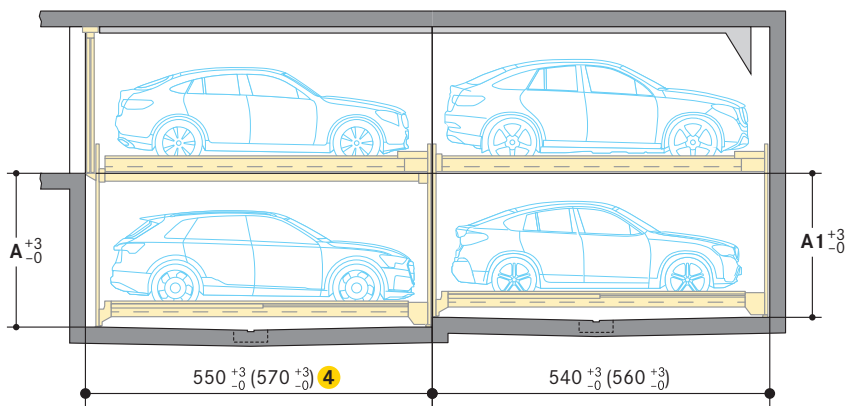

Type 1 2	Pit depth A	Pit depth A1
542_MR-190	190	175
542_MR-195	195	180
542_MR-200	200	185
542_MR-205	205	190
542_MR-210	210	195
542_MR-215	215	200
542_MR-220	220	205
542_MR-225	225	210
542_MR-230	230	215
542_MR-235	235	220
542_MR-240	240	225
542_MR-245	245	230
542_MR-250	250	235
542_MR-255	255	240
542_MR-260	260	245

- 1** WÖHR recommends a straight pit. This simplifies the concreting work and compliance with the dimensions.
- 2** Due to the 15 cm deeper pit of the MR system, the same vehicle heights can be parked in the lower parking spaces in all rows
- 3** Substructure for Combilift is included
- 4** Pit depth 250 and 255: +10 cm
Pit depth 260: +20 cm

Top view

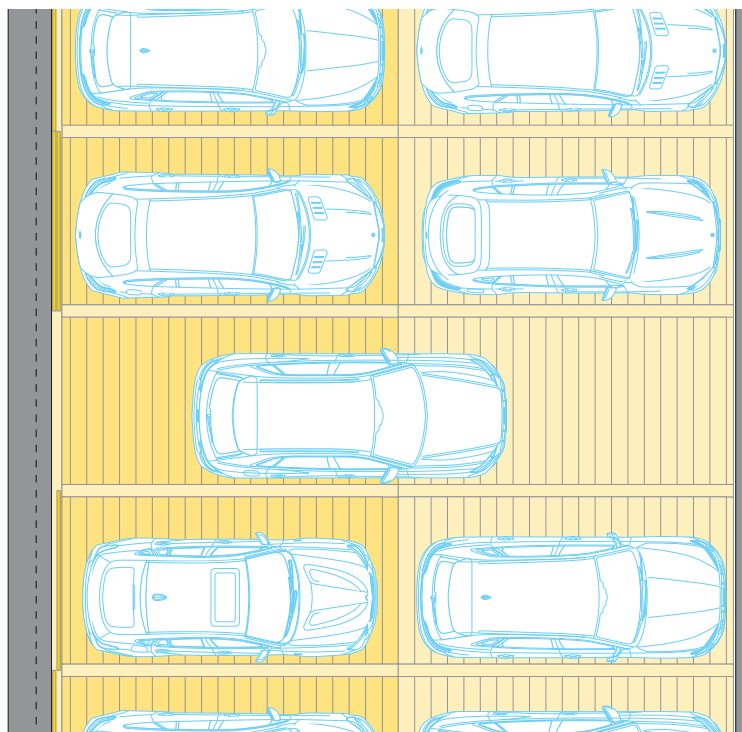

Pit dimensions with intermediate walls

Straight pit:

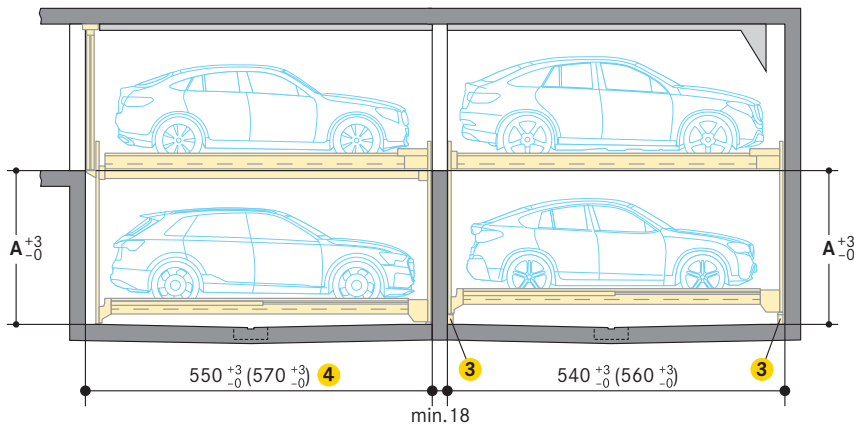

Stepped pit:

- without extra costs for Combilift

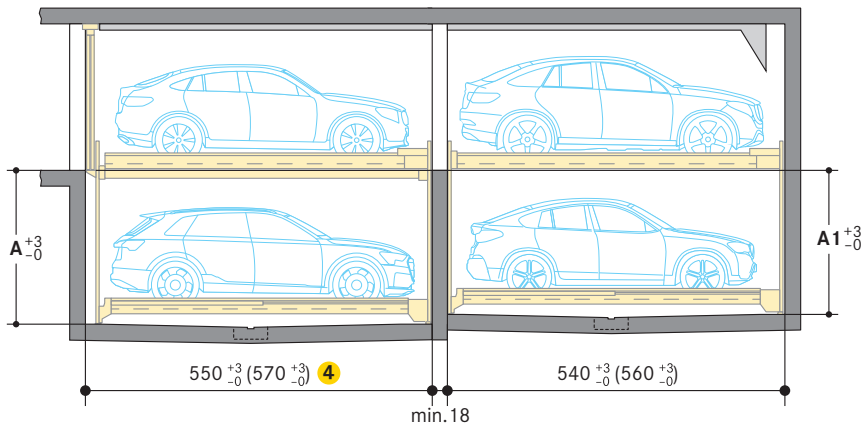

Top view

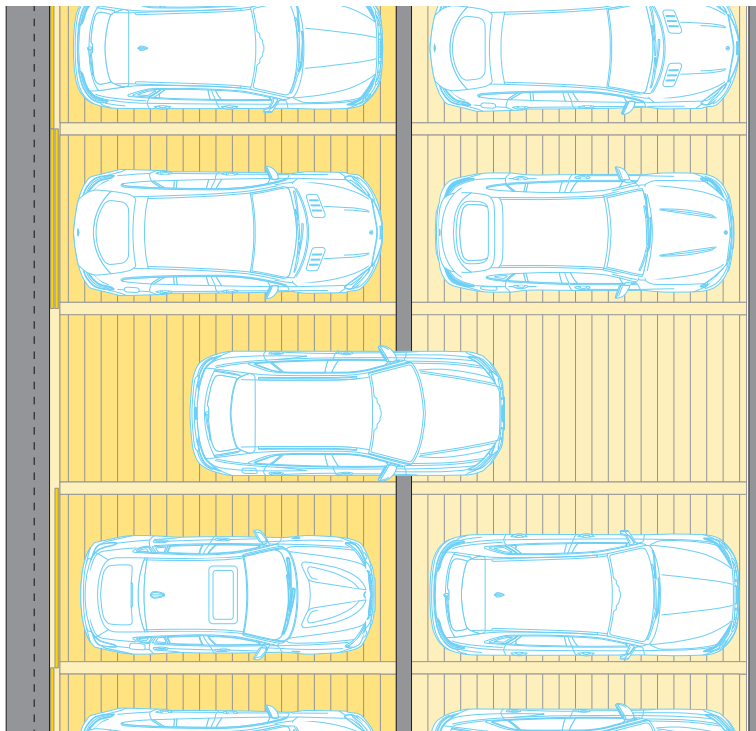

Type	1	2	Pit depth A	Pit depth A1
542_MR-190			190	175
542_MR-195			195	180
542_MR-200			200	185
542_MR-205			205	190
542_MR-210			210	195
542_MR-215			215	200
542_MR-220			220	205
542_MR-225			225	210
542_MR-230			230	215
542_MR-235			235	220
542_MR-240			240	225
542_MR-245			245	230
542_MR-250			250	235
542_MR-255			255	240
542_MR-260			260	245

- 1 WÖHR recommends a straight pit. This simplifies the concreting work and compliance with the dimensions.
- 2 Due to the 15 cm deeper pit of the MR system, the same vehicle heights can be parked in the lower parking spaces in all rows
- 3 Substructure for Combilift is included
- 4 Pit depth 250 and 255: +10 cm
Pit depth 260: +20 cm

Pit dimensions with pillars

Straight pit:

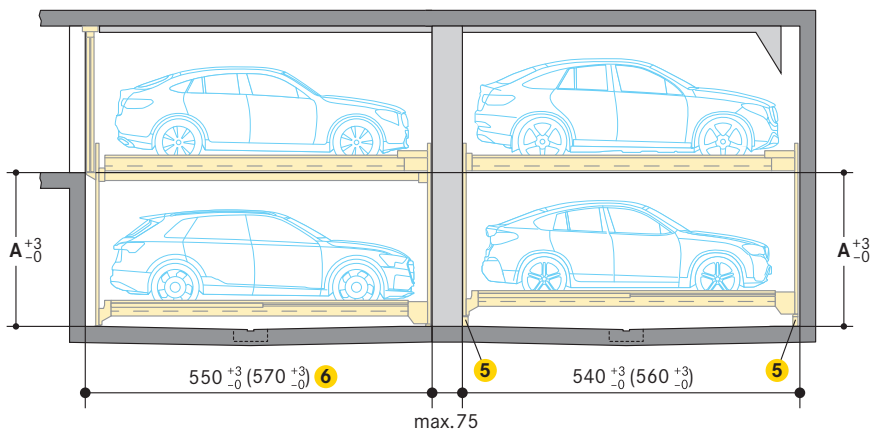

Stepped pit:

- without extra costs for Combilift

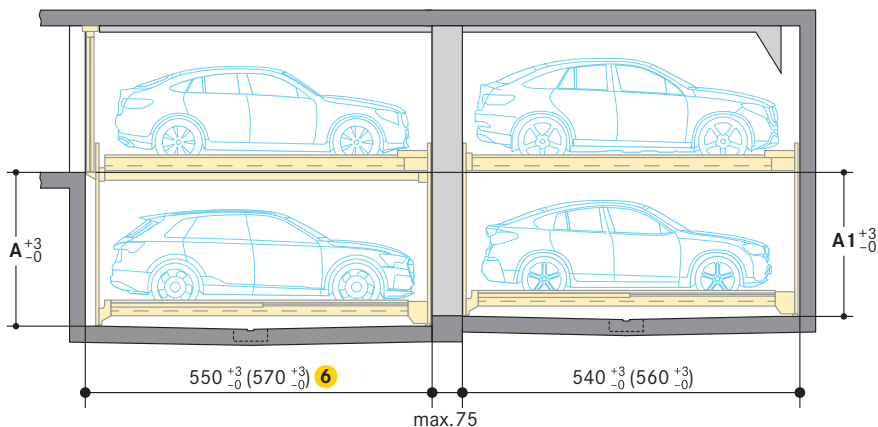

Top view

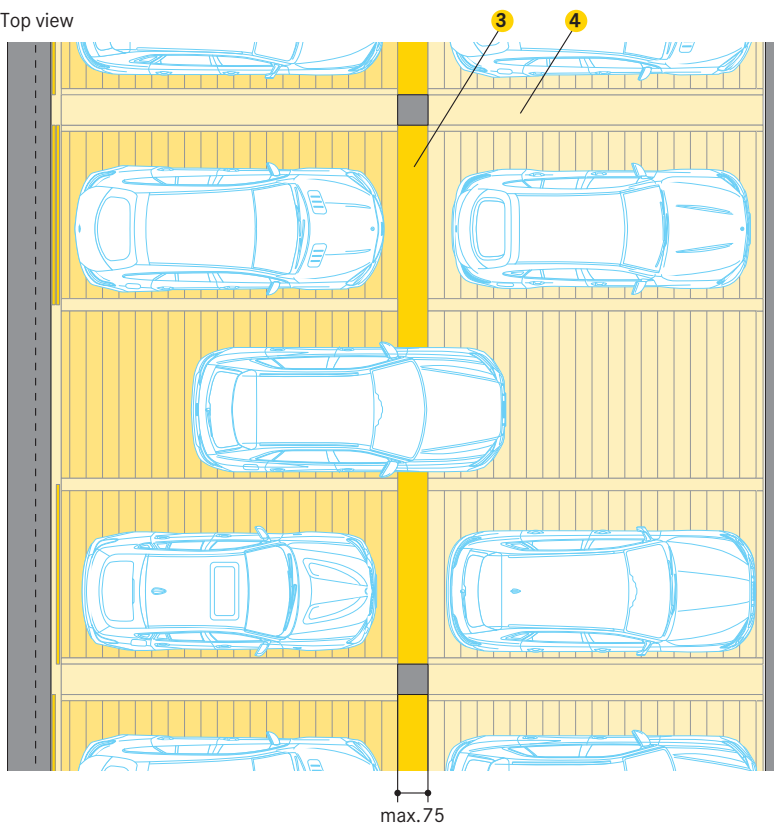

Type 1 2	Pit depth A	Pit depth A1
542_MR-190	190	175
542_MR-195	195	180
542_MR-200	200	185
542_MR-205	205	190
542_MR-210	210	195
542_MR-215	215	200
542_MR-220	220	205
542_MR-225	225	210
542_MR-230	230	215
542_MR-235	235	220
542_MR-240	240	225
542_MR-245	245	230
542_MR-250	250	235
542_MR-255	255	240
542_MR-260	260	245

- 1 WÖHR recommends a straight pit. This simplifies the concreting work and compliance with the dimensions.
- 2 Due to the 15 cm deeper pit of the MR system, the same vehicle heights can be parked in the lower parking spaces in all rows
- 3 Drive over metal sheet at extra cost
- 4 Steel structure separation required at extra cost
- 5 Substructure for Combilift is included
- 6 Pit depth 250 and 255: +10 cm
Pit depth 260: +20 cm

Clearance profile (for standard vehicles)

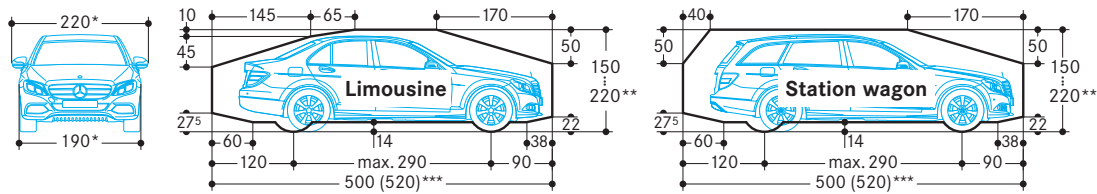

* for a 250 cm platform width
 ** The overall vehicle height including roof luggage rails an antenna mounts must not exceed the max. vehicle height dimensions specified
 *** see page 1

Width dimensions

Platform widths:

- 250 cm:
 - for 190 cm vehicle width (without outside mirror)
- 260-300 cm:
 - for vehicles wider than 190 cm (without outside mirror)

- 270-300 cm:
 - for units at the end of the driving aisle

For comfortable parking, entry and exit conditions platform widths upon 270 cm are recommended.

Reduced platform width means reduced parking comfort depending on the vehicle width, vehicle type, individual driving style, access situation of the (underground) garage.

With a 90° arrangement of the parking places, we recommend widening the driving aisle to at least 700 cm or a wall recess (see below).

Width dimensions (underground car park)

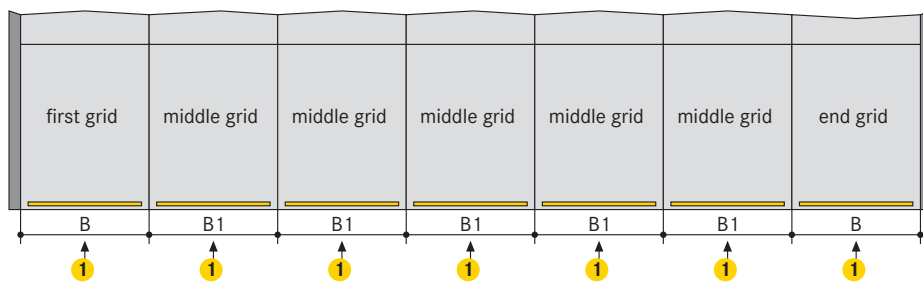
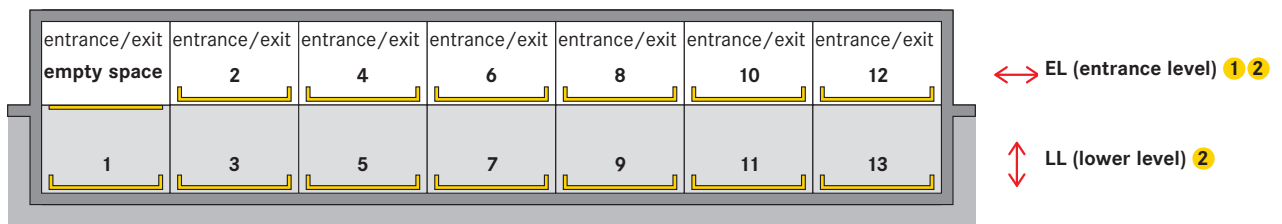

Space requirements		clear platform width
B	B1	
280	270	250
290	280	260
300	290	270
310	300	280 ③
320	310	290 ③
330	320	300 ③

- ① One entry/exit is required on entrance level (EL) for each grid
- ② For a comfortable parking process and comfortable conditions for getting in and out of the car, we recommend platform widths of at least 270 cm. Smaller platform widths are possible but not recommended (please contact WÖHR).
- ③ Platform load max. 2.600 kg
- ④ It is not possible to combine different platform widths

Wall recess

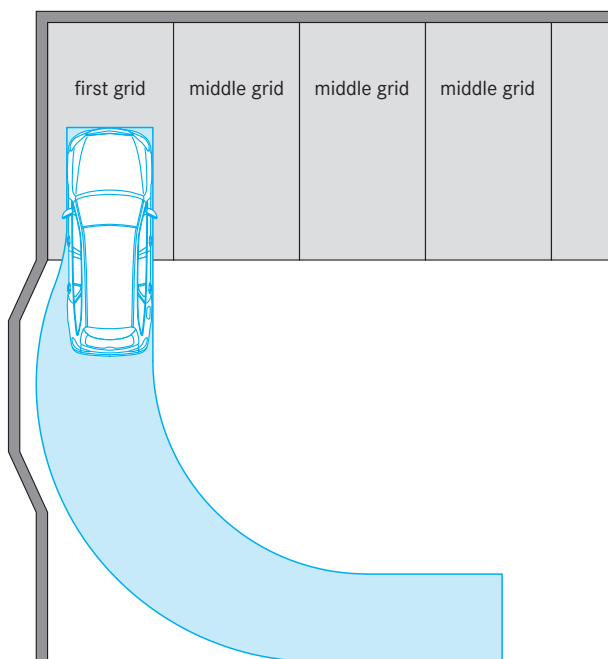

According to GaVo for Baden-Württemberg (07.07.1997/26.01.2011): For parking places with a 90° arrangement at the end of the driving aisle, the entrance width must be min. 275 cm.

At the end of the driving aisle, we recommend to provide a wall recess, if technically possible.

Doors

According to DIN EN 14010 doors are required.

Automatic sliding doors:

- electrical drive
- controls are integrated in the overall system
- electro-mechanically interlocked
- can only be opened when the selected parking place has reached the entry/exit position
- any crash openings are closed in the entrance area

Local requirements for electrical doors regarding the technology, maintenance and revision are not subject of our delivery. These matters have to be observed and carried out by the customer, according to the local regulations.

Sliding doors behind the building pillars with door offset

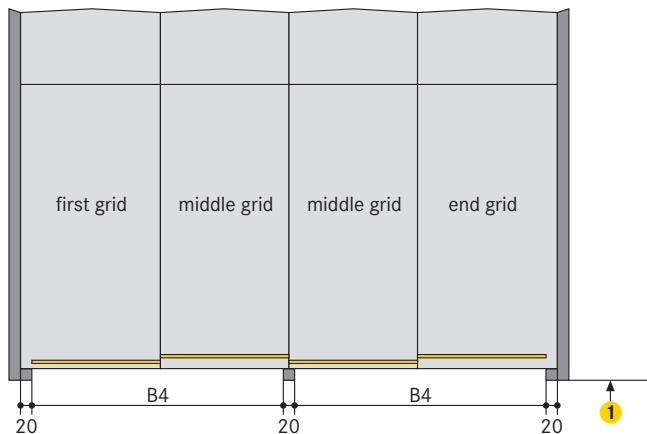

Space requirements B4	clear platform width
520	250
540	260
560	270
580	280 ②
600	290 ②
620	300 ②

- ① The driving aisle width must comply with local regulations
- ② Platform load max. 2600 kg
- ③ For MR-systems:
Pit depth 250 and 255: +10 cm
Pit depth 260: +20 cm

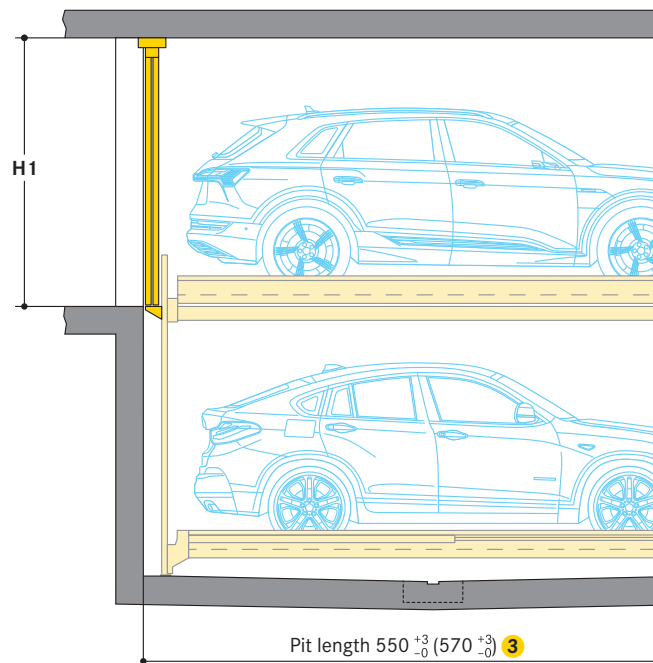

	Vehicle height EL (entrance level)				
	200	205	210	215	220
H1	220	225	230	235	240

Sliding doors below the lintel between the building pillars

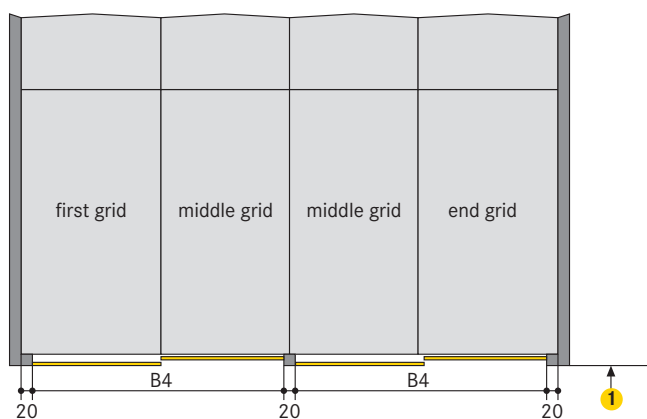

Space requirements B4	clear platform width
520	250
540	260
560	270
580	280 ②
600	290 ②
620	300 ②

- ① The driving aisle width must comply with local regulations
- ② Platform load max. 2600 kg
- ③ For MR-systems:
Pit depth 250 and 255: +10 cm
Pit depth 260: +20 cm

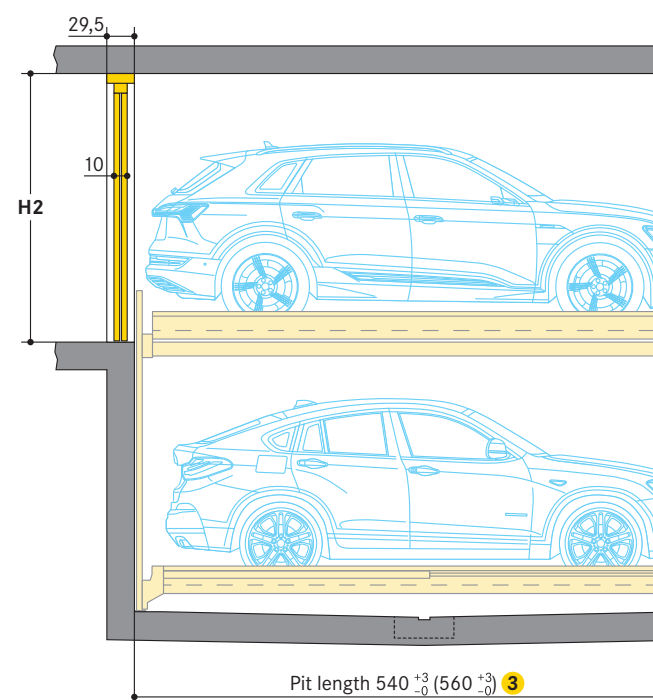

	Vehicle height EL (entrance level)				
	200	205	210	215	220
H2	220	225	230	235	240

Sliding door floor guides

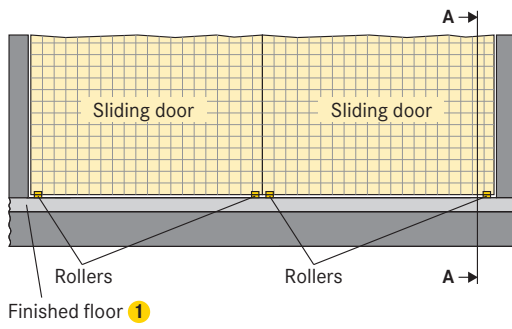

- ① Finished floor:
 - compliant to DIN 18353,
 - floor evenness compliant to DIN 18202, table 3, line 3
- ② Floor guide section:
 - base plate with plastic rollers
 - fixed on the floor with adhesive anchor (M8 internal screw thread)
 - borehole depth approx. 9 cm
 - in the event that floor filling needs to be laid into the door section to the purpose of reaching the required floor evenness, the borehole depth needs to be increased by the thickness of the floor fill (max. 4 cm)
- ③ If the driving aisle is made of concrete blocks, asphalt etc., the concrete slab of the pit edge in the door area must be min. 29,5 cm wide

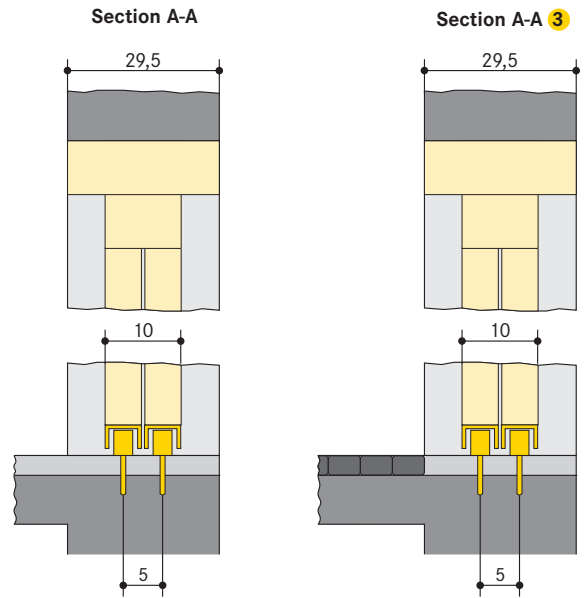

Static calculations and construction works requirement

Section

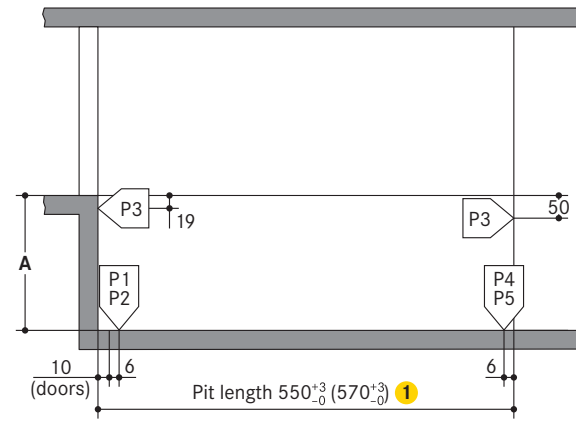

Type	A
542-175	175
542-180	180
542-185	185
542-190	190
542-195	195
542-200	200
542-205	205
542-210	210
542-215	215
542-220	220
542-225	225
542-230	230
542-235	235
542-240	240
542-245	245

Type	A
542_MR-190	190
542_MR-195	195
542_MR-200	200
542_MR-205	205
542_MR-210	210
542_MR-215	215
542_MR-220	220
542_MR-225	225
542_MR-230	230
542_MR-235	235
542_MR-240	240
542_MR-245	245
542_MR-250	250
542_MR-255	255
542_MR-260	260

542 (2000 kg)	
P1	+ 38,0 kN*
P2	+ 19,0 kN
P3	± 2,5 kN
P4	± 20,0 kN
P5	± 10,0 kN

542 (2600 kg)	
P1	+ 46,0 kN*
P2	+ 23,0 kN
P3	± 2,5 kN
P4	± 24,0 kN
P5	± 12,0 kN

542 (3000 kg)	
P1	+ 52,0 kN*
P2	+ 26,0 kN
P3	± 2,5 kN
P4	± 26,0 kN
P5	± 13,0 kN

542_MR (2000 kg)	
P1	+ 29,0 kN*
P2	+ 15,0 kN
P3	± 2,5 kN
P4	± 15,0 kN
P5	± 8,0 kN

542_MR (2600 kg)	
P1	+ 37,7 kN*
P2	+ 19,7 kN
P3	± 3,3 kN
P4	± 19,5 kN
P5	± 10,4 kN

542_MR (3000 kg)	
P1	+ 43,5 kN*
P2	+ 22,7 kN
P3	± 3,8 kN
P4	± 17,9 kN
P5	± 12,0 kN

*specified load bearing data includes the vehicle weight

Ground plan

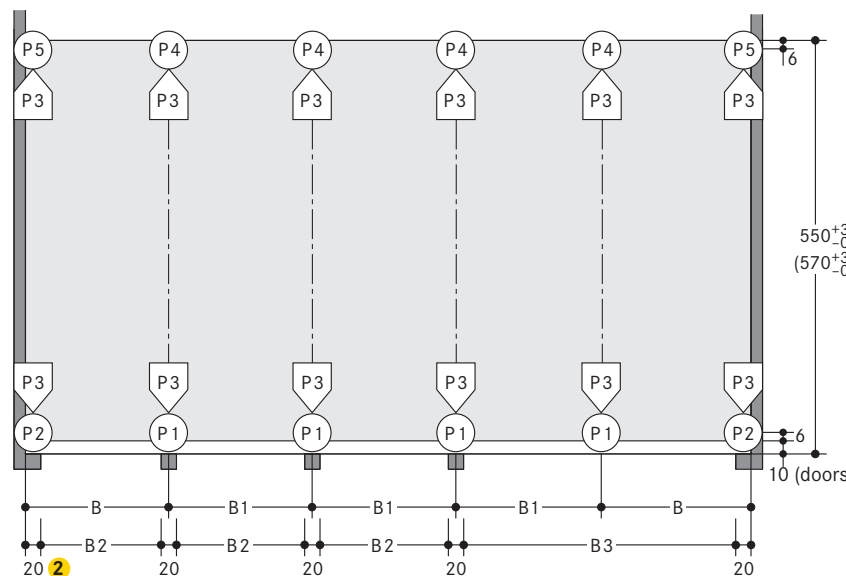

Fixing of the system frames to the floor slab:

- using base plates (approx. 350 cm²)
- using adhesive anchor bolts
- hole depth to 12- 14 cm
- bottom plate in concrete
- thickness of bottom plate min. 18 cm

Fixing of the system frames to the walls:

- with walls plates (approx. 30 cm²)
- using adhesive anchor bolts
- hole depth to 12- 14 cm
- front drive-in wall and rear wall in concrete
- perfectly flat wall surfaces
- without protruding sections such as border edgings, pipes and tubes, etc.
- thickness of walls min. 18 cm

Concrete quality grade:

- compliant to the static requirements of the construction
- min. C20/25 grade (for dowel fastening)

Frame bearing points:

- the specified lengths are expressed as mean value
- for the exact data, specific TÜV-tested data sheets are available

Door widths/widths of columns:

- please contact WÖHR
- grid width (270/280/290/300/310/320) must be observed

Space requirements				clear platform width
B	B1	B2	B3	
280	270	250	520	250
290	280	260	540	260
300	290	270	560	270
310	300	280	580	280 ③
320	310	290	600	290 ③
330	320	300	620	300 ③

① For MR-systems:
Pit depth 250 and 255: +10 cm
Pit depth 260: +20 cm

② If the width of the pillars is more than 20 cm, than the width of the drive through will be reduced accordingly to the above mentioned width dimensions (B and B1). In order to avoid this, we recommend to extend the measures between the pillars (B2 and B3) accordingly. Please contact WÖHR.

③ Platform load max. 2600 kg

Electrical specifications

Installation diagram

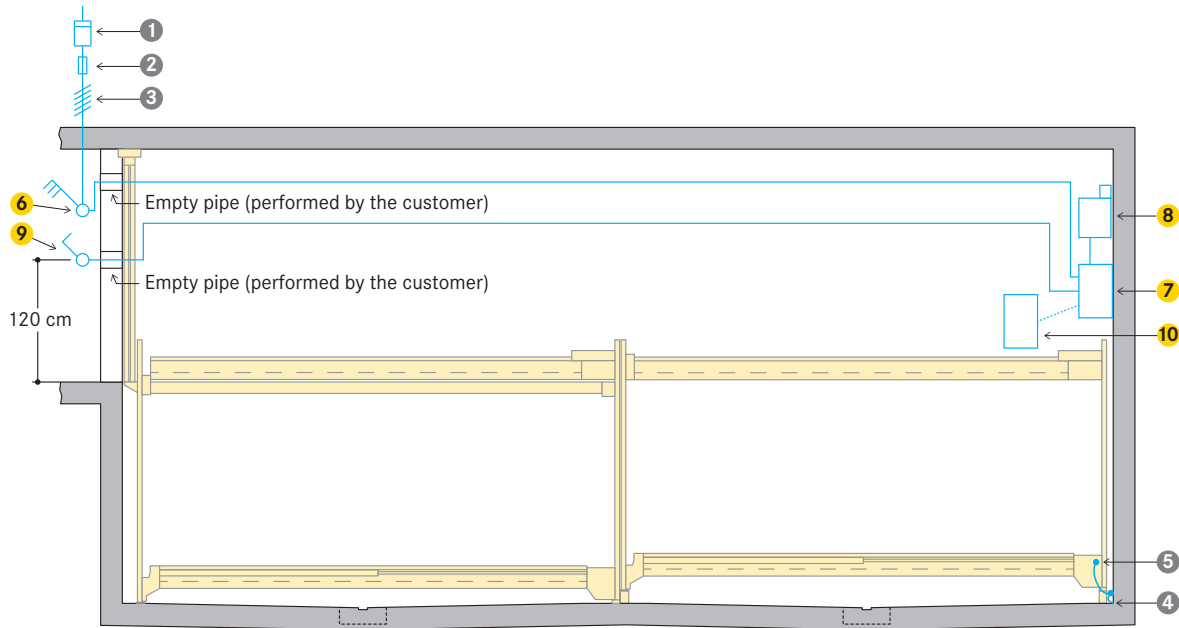

Cabling preparation to be performed by the customer:

- up to the main switch to be in place prior to starting the installation operations
- connection to the main switch during installation
- system functional check testing can be performed by WÖHR together with the electrician provided by the customer
- if requested at a later date, functional check testing can be performed by WÖHR at extra-cost

Grounding and potential equalisation (to be performed by the customer):

- compliant to DIN EN 60204
- connections required every 10 metres

To be performed by the customer

Item	Quantity	Description	Position	Recurrence				
1	1 piece	Power meter	In the feed cable					
2	1 piece	Fuse protection or automatic circuit breaker:*	In the feed cable	1 x per system				
		Rows			Motor	Starting current	Fuse protection	Platform load
		1			3,0 kW	24 A	3 x 16 A (11 kW)	2000 kg/2600 kg
		2			3,0 kW	48 A	3 x 32 A (22 kW)	2000 kg/2600 kg
		3			3,0 kW	72 A	3 x 40 A (28 kW)	2000 kg/2600 kg
		4			3,0 kW	96 A	3 x 63 A (44 kW)	2000 kg/2600 kg
		1			5,5 kW	57 A	3 x 32 A (22 kW)	3000 kg
		2			5,5 kW	114 A	3 x 63 A (44 kW)	3000 kg
3	5,5 kW	171 A	3 x 100 A (69 kW)	3000 kg				
4	5,5 kW	228 A	3 x 125 A (86 kW)	3000 kg				
3	Based on site conditions	Compliant to local power supply regulations 3 phases + N + PE* 230/400 V, 50 Hz	Feed cables to main switch including connection	1 x per system				
4	Every 10 m	Grounding and potential equalisation lead-out connection	Along pit floor edges/rear wall					
5	1 piece	Grounding and potential equalisation compliant to DIN EN 60204	From lead-out connection to system	1 x per system				

* Compliant to DIN VDE 0100 sections 410 and 430 (no permanent load) 3 phases + N+ PE (three phase current)

Scope of delivery by WÖHR (unless otherwise specified in the order)

Item	Description
6	Lockable main switch
7	Main switch cabinet for grid 1-4
8	Hydraulic power pack 3.0 kW (5.5 kW for platform load 3000 kg) with three-phase motor. Ready-wired switching cabinet with motor safety contactor
9	Operating device
10	Extra switch cabinet for grid 5-8

Notes and directions

Scope of application

- suitable for residential buildings, office buildings and business premises, hotels
- only for long-term users that have been instructed on how to use the system
- for frequently changing users (e.g. for office, hotel and business premises or similar):
 - performance of technical system adjustments is necessary
 - please consult with WÖHR

Function

- one empty space per unit on entrance level
- platforms on entrance level are moved sideways
- platforms on the lower level are lifted to the empty space on the entrance level

Numbering of the parking places

- empty space on the entrance level on the left
- numbering single system:

-	2	4
1	3	5

Combilift 542

- numbering MR-system:

-	7	9	
6	8	10	
-	2	4	
1	3	5	

-	12	14
11	13	15
-	7	9
6	8	10
-	2	4
1	3	5

-	17	19
16	18	20
-	12	14
11	13	15
-	7	9
6	8	10
-	2	4
1	3	5

Combilift 542 (552/543)

Combilift 542_MR

Combilift 542_MR

Combilift 542_MR

- the numbering for each unit starts with 1
- different numbering of parking places is possible at extra cost (software changes are necessary)

Noise protection

Basis is the German DIN 4109 "Noise protection in buildings".

With the following conditions required 30 dB (A) in rooms can be provided:

- noise protection package from our accessory
- insulation figure of the construction of min. $R'_{w} = 57$ dB
- walls which are bordering the parking systems must be done as single wall and deflection resistant with min. $m' = 300$ kg/m²
- solid ceiling above the parking systems with min. $m' = 400$ kg/m²

At differing constructional conditions additional sound absorbing measures are to be provided by the customer.

The best results are reached by separated sole plates from the construction.

Increased sound insulation (separate agreement):

It is based on VDI 4100 „Sound insulation in building construction“ Assessment and proposals for increased sound insulation.

Under the following conditions, 25 dB (A) can be complied with in living spaces and bedrooms:

- sound insulation package according to offer/order
- Sound insulation value of the building structure of min. $R'_{w} = 62$ dB (to be performed by the customer)

Note:

User noises are not subject to the requirements (see VDI 4100, Scope - Notes). User noises are basically noises that can be individually influenced by the user of the parking systems (e.g. driving on the platform, closing of vehicle doors, engine and brake noises).

Drainage

Water leaks into the pit:
 - in the winter, up to 40 litres of snow water can possibly come with the wheel housings in just one parking process

Drainage channels:

- along the middle section of the pit
- connecting to a floor drain or drainage pit (50 x 50 x 20 cm)
- with manual emptying out of the drainage pit
- alternatively installation of a pump or drainage channel into the sewerage system, to be performed by the customer

Sideways slope drainage:

- only into a gutter
- not possible in the remaining pit section

Lengthways slope drainage:

- provided according to specified construction dimensions

Environmental safety:

- coating of the pit flooring is recommended
- installation of an oil and/or petrol separator unit between the drainage connection and the main sewerage system is recommended

Declaration of conformity



The parking systems are compliant to:
 - EC Machinery Directive 2006/42/EC
 - DIN EN 14010
 - ISO 9001:2015

Hydraulic power pack

Arrangement of the hydraulic power pack:
 - within the unit

Switch cabinet

Arrangement of the switch cabinet:
 - within the unit

Temperature

- system operating range: +5° bis +40°C (with unloaded platforms and low temperatures, a reduced lowering speed is to be expected)
- humidity: 50 % at +40° C
- if use in deviating temperature ranges is planned, constructive adjustments may be necessary (please consult with WÖHR)

Lighting

- sufficient lighting of the driving aisle and of the parking places must be performed by the customer

Fire safety

- all fire safety requirements and all mandatory equipment (fire extinguisher and fire alarm systems, etc.) must be performed by the customer
- WÖHR will provide documents on attachment points and clearances for sprinklers on request

Railings

If walkways are arranged directly to the side or behind the systems, railings have to be provided by the customer acc. to local requirements, height min. 200 cm - this is applicable during the construction phase too.

Maintenance

- WÖHR and all the WÖHR partners abroad provide an installation and customer service network
- regular, annual maintenance is provided subject to the stipulation of a maintenance agreement
- local requirements for electrical doors regarding the technology, maintenance and revision are not subject of our delivery. These matters have to be observed and carried out by the customer, according to the local regulations.

Prevention of corrosion damage

- all operations listed in the WÖHR Cleaning and Maintenance Instructions are to be performed regularly (independently of maintenance operations)
- zinc-plated parts, components and platforms are to be kept clean of dirt, road-salt and any other debris (due to corrosion hazards)
- always keep the garage well ventilated and deaerated



Surface protection

- please consider the information on surface protection!



Tender specification

- please consider the specifications!



Parking Place-Profile

- please consider the product information Parking Place-Profile!



Electromobility

- please consider the product information power supply!
- depending on the position of the charging point on the electric vehicle, collision points with protruding plugs and charging cables can occur

Sliding doors and Operating concepts

- please consider the product information Sliding doors and Operating concepts!



Construction formalities

- the documentation necessary for construction permit applications is provided by WÖHR on demand

Construction alterations and/or modifications

- the right to construction or model modifications and/or variations is hereby reserved
- the right to any subsequent part modification and/or variation and amendments in procedures and standards due to technical and engineering progresses or due to environmental regulation changes is also hereby reserved